

# **Villa Door Station**

## **User's Manual**



V1.0.0





# Foreword

## General

This manual introduces the installation, functions and operations of the villa door station device (hereinafter referred to as "the VTO"). Read carefully before using the device, and keep the manual safe for future reference.

## Safety Instructions

The following signal words might appear in the manual.

Signal Words	Meaning
 DANGER	Indicates a high potential hazard which, if not avoided, will result in death or serious injury.
 WARNING	Indicates a medium or low potential hazard which, if not avoided, could result in slight or moderate injury.
 CAUTION	Indicates a potential risk which, if not avoided, could result in property damage, data loss, reductions in performance, or unpredictable results.
 NOTE	Provides additional information as a supplement to the text.

## Revision History

Version	Revision Content	Release Date
V1.0.0	First release.	November 2024

## Privacy Protection Notice

As the device user or data controller, you might collect the personal data of others such as their face, audio, fingerprints, and license plate number. You need to be in compliance with your local privacy protection laws and regulations to protect the legitimate rights and interests of other people by implementing measures which include but are not limited to: Providing clear and visible identification to inform people of the existence of the surveillance area and provide required contact information.

## About the Manual

- The manual is for reference only. Slight differences might be found between the manual and the product.
- We are not liable for losses incurred due to operating the product in ways that are not in compliance with the manual.
- The manual will be updated according to the latest laws and regulations of related jurisdictions. For detailed information, see the paper user's manual, use our CD-ROM, scan the QR code or visit our official website. The manual is for reference only. Slight differences might be found between the electronic version and the paper version.

- All designs and software are subject to change without prior written notice. Product updates might result in some differences appearing between the actual product and the manual. Please contact customer service for the latest program and supplementary documentation.
- There might be errors in the print or deviations in the description of the functions, operations and technical data. If there is any doubt or dispute, we reserve the right of final explanation.
- Upgrade the reader software or try other mainstream reader software if the manual (in PDF format) cannot be opened.
- All trademarks, registered trademarks and company names in the manual are properties of their respective owners.
- Please visit our website, contact the supplier or customer service if any problems occur while using the device.
- If there is any uncertainty or controversy, we reserve the right of final explanation.

# Important Safeguard and Warnings

This section introduces content covering the proper handling of the device, hazard prevention, and prevention of property damage. Read carefully before using the device, and comply with the guidelines when using it.

## Installation Requirements



### WARNING

- Do not connect the power adapter to the device while the adapter is powered on.
- Do not connect the device to two or more kinds of power supplies, to avoid damage to the device.
- Please follow the electrical requirements to power the device.
  - ◇ Following are the requirements for selecting a power adapter.
    - The power supply must conform to the requirements of IEC 60950-1 and IEC 62368-1 standards.
    - The voltage must meet the SELV (Safety Extra Low Voltage) requirements and not exceed ES-1 standards.
    - When the power of the device does not exceed 100 W, the power supply must meet LPS requirements and be no higher than PS2.
  - ◇ We recommend using the power adapter provided with the device.
  - ◇ When selecting the power adapter, the power supply requirements (such as rated voltage) are subject to the device label.



- Personnel working at heights must take all necessary measures to ensure personal safety including wearing a helmet and safety belts.
- Do not place the device in a place exposed to sunlight or near heat sources.
- Keep the device away from dampness, dust, and soot.
- Install the device on a stable surface to prevent it from falling.
- Install the device in a well-ventilated place, and do not block its ventilation.
- Use an adapter or cabinet power supply provided by the manufacturer.
- Use the power cords that are recommended for the region and conform to the rated power specifications.
- The device is a class I electrical appliance. Make sure that the power supply of the device is connected to a power socket with protective earthing.

## Operation Requirements



### DANGER

#### Battery Pack Precautions

Preventive measures (including but not limited to):

- Do not transport, store or use the batteries in high altitudes with low pressure and environments with extremely high and low temperatures.
- Do not dispose the batteries in fire or a hot oven, or mechanically crush or cut the batteries to avoid an explosion.

- Do not leave the batteries in environments with extremely high temperatures to avoid explosions and leakage of flammable liquid or gas.
- Do not subject the batteries to extremely low air pressure to avoid explosions and the leakage of flammable liquid or gas.



- Check whether the power supply is correct before use.
- Do not unplug the power cord on the side of the device while the adapter is powered on.
- Operate the device within the rated range of power input and output.
- Transport, use and store the device under allowed humidity and temperature conditions.
- If the device is powered off for longer than a month, it should be placed in its original package and sealed. Make sure to keep it away from moisture, and store it under allowed humidity and temperature conditions.
- Do not drop or splash liquid onto the device, and make sure that there is no object filled with liquid on the device to prevent liquid from flowing into it.
- Do not disassemble the device without professional instruction.

# Table of Contents

Foreword.....	I
Important Safeguard and Warnings.....	III
1 Structure.....	1
1.1 Villa Door Station (Multiple Buttons).....	1
1.1.1 Front Panel.....	1
1.1.2 Rear Panel.....	2
1.2 Villa Door Station (Single Button).....	3
1.2.1 R Series.....	3
1.2.2 D Series.....	5
1.2.3 G Series.....	8
1.2.4 E Series.....	9
1.2.5 F Series.....	15
1.3 Button Model.....	26
1.3.1 Front Panel.....	26
1.3.2 Rear Panel.....	27
2 Initializing the VTO.....	29
2.1 Web .....	29
2.2 DMSS APP.....	29
3 Login and Resetting Password.....	33
3.1 Login.....	33
3.2 Resetting Password.....	33
4 Home Page.....	35
5 Setup Wizard.....	36
5.1 Setting as SIP Server.....	36
5.2 Not Setting as SIP Server.....	37
6 Local Device Configuration.....	38
6.1 Basic Settings.....	38
6.1.1 Villa Door Station.....	38
6.1.2 Second Confirmation Station.....	41
6.2 Access Control.....	43
6.2.1 Configuration.....	43
6.2.2 Extension Function.....	44
6.3 Light Control.....	47
6.4 Card Settings.....	48
6.5 Wiegand Settings.....	48
6.6 Layout.....	50
6.6.1 Layout (Multiple Buttons).....	50

6.6.2	Layout (Multiple Modules).....	52
6.7	Adding IPC.....	55
6.7.1	Adding IPC One by One.....	56
6.7.2	Exporting IPC Information in Batches.....	58
6.7.3	Importing IPC Information in Batches.....	58
7	Device Setting.....	59
7.1	VTO Management.....	59
7.2	VTH Management.....	60
7.3	VTS Management.....	62
8	Person Management.....	64
9	Network Settings.....	67
9.1	TCP/IP.....	67
9.2	Port.....	68
9.3	SIP Server.....	69
9.4	Second Confirmation Station Cascading.....	72
9.5	Cloud Service.....	73
9.6	UPnP.....	74
9.6.1	Enabling UPnP Services.....	74
9.6.2	Adding UPnP Services.....	74
9.7	Wi-Fi.....	76
9.8	Basic Services.....	76
9.9	Auto Registration.....	78
10	System.....	80
10.1	Alarm.....	80
10.2	Video.....	81
10.3	Audio.....	84
10.4	Time.....	85
10.5	ONVIF User.....	87
11	Log Management.....	89
11.1	One-Click Diagnosis.....	89
11.2	System Information.....	89
11.2.1	Version Information.....	89
11.2.2	Legal Information.....	90
11.3	Data Capacity.....	90
11.4	Maintenance Management.....	90
11.4.1	Config.....	90
11.4.2	Maintenance.....	91
11.5	Update.....	91
11.6	Advanced Maintenance.....	92
12	Security Management.....	93

<b>12.1 Security Status.....</b>	<b>93</b>
<b>12.2 System Service.....</b>	<b>93</b>
<b>12.3 Attack Defense.....</b>	<b>94</b>
<b>12.3.1 Firewall.....</b>	<b>94</b>
<b>12.3.2 Account Lockout.....</b>	<b>95</b>
<b>12.3.3 Anti-DoS Attack.....</b>	<b>96</b>
<b>12.4 CA Certificate.....</b>	<b>96</b>
<b>12.5 Video Encryption.....</b>	<b>97</b>
<b>12.6 Security Warning.....</b>	<b>97</b>
<b>13 Button Model Configuration.....</b>	<b>99</b>
<b>13.1 Cable Connection.....</b>	<b>99</b>
<b>13.2 VTH Configuration.....</b>	<b>100</b>
<b>Appendix 1 Security Recommendation.....</b>	<b>102</b>



# 1 Structure

## 1.1 Villa Door Station (Multiple Buttons)

### 1.1.1 Front Panel

Figure 1-1 Front panel

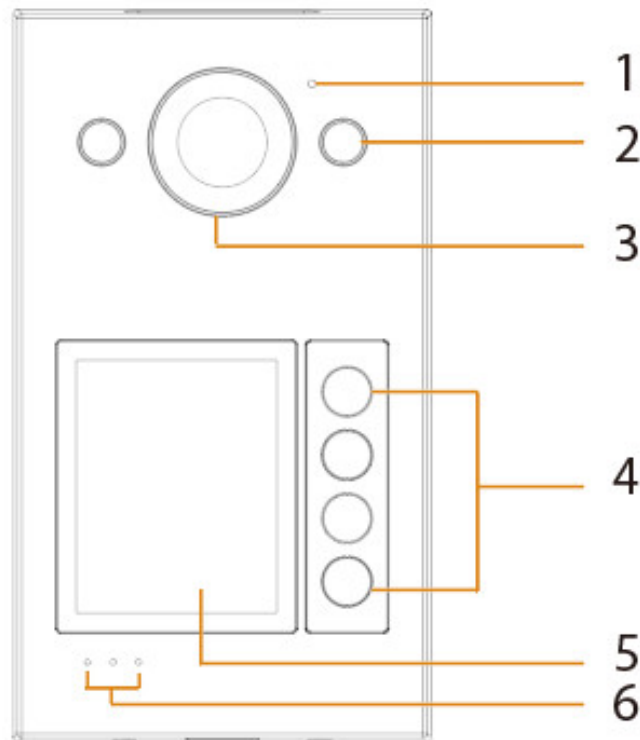

Table 1-1 Components

No.	Name	Function
1	MIC	Audio input.
2	Illuminator	Provides a constant light to focus more easily on a subject in dark surroundings.
3	Camera	Captures images or record videos for the VTO.
4	Call buttons	Calls the VTH.
5	Card swiping area	Swipes the registered cards to unlock doors.
6	Indicators	From left to right: <ul style="list-style-type: none"> <li>● Ring: VTO is calling the VTH.</li> <li>● Talking: VTO is on the talk with the VTH.</li> <li>● Unlocking: VTO is unlocking successful.</li> </ul>

## 1.1.2 Rear Panel



The multi-function port might differ depending on the actual models.

Figure 1-2 Rear panel

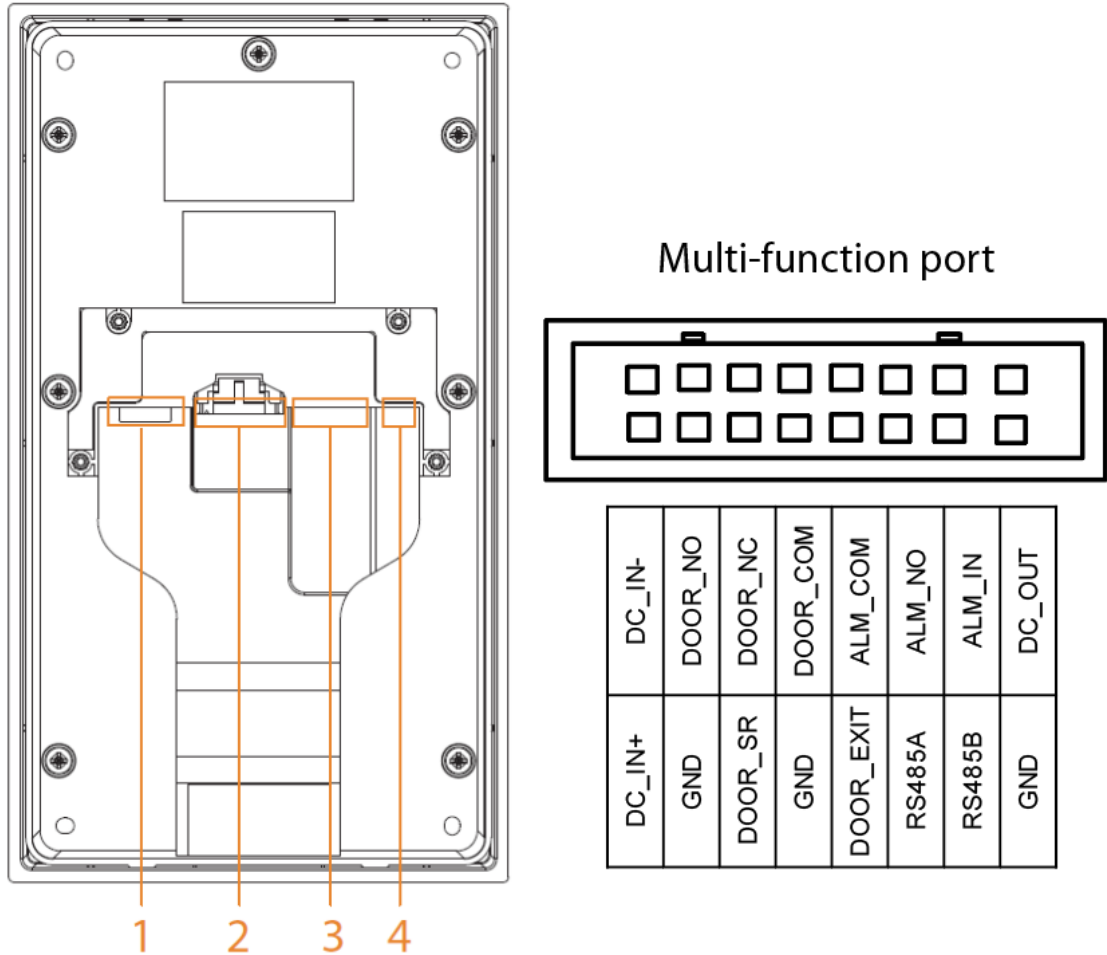

Table 1-2 Components

No.	Name	Function
1	SD card slot	Used to insert SD card so that data information such as images and videos can be stored.
2	Multi-function port	Alarm port, door detector port, 485 port, power port and other ports.
3	Network port	RJ-485 network port to connect to the network.
4	Reset button	Press and hold the button for several seconds to reset to factory settings.

## 1.2 Villa Door Station (Single Button)

### 1.2.1 R Series

#### 1.2.1.1 Front Panel

Size and appearance might differ depending on the models of product.

Figure 1-3 Front panel

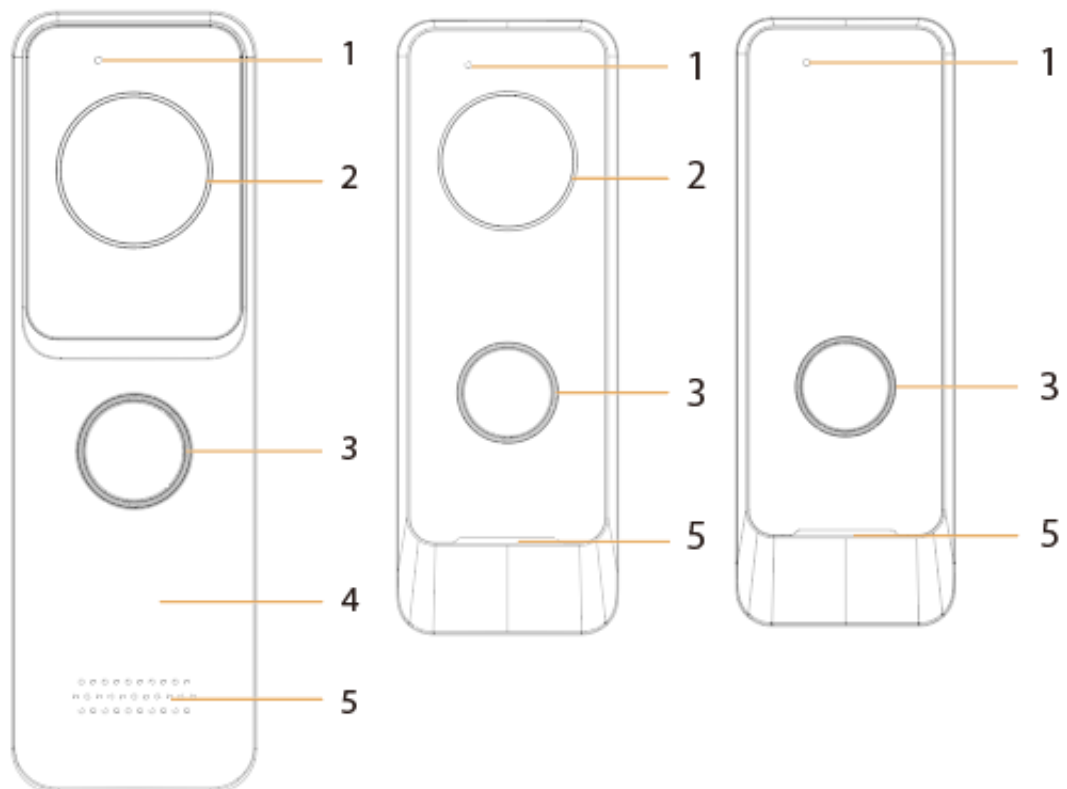

Table 1-3 Components

No.	Name	Function
1	MIC	Audio input.
2	Camera	Capture images or record videos for the VTO.
3	Call button	Call the VTH.
4	Card swiping area	Swipe the registered cards to unlock doors. The card swiping function is only available on select models.
5	Speaker	Audio output.

## 1.2.1.2 Rear Panel



The multi-function port might differ depending on the model. Here are two models used as examples.

Figure 1-4 Rear panel (1)

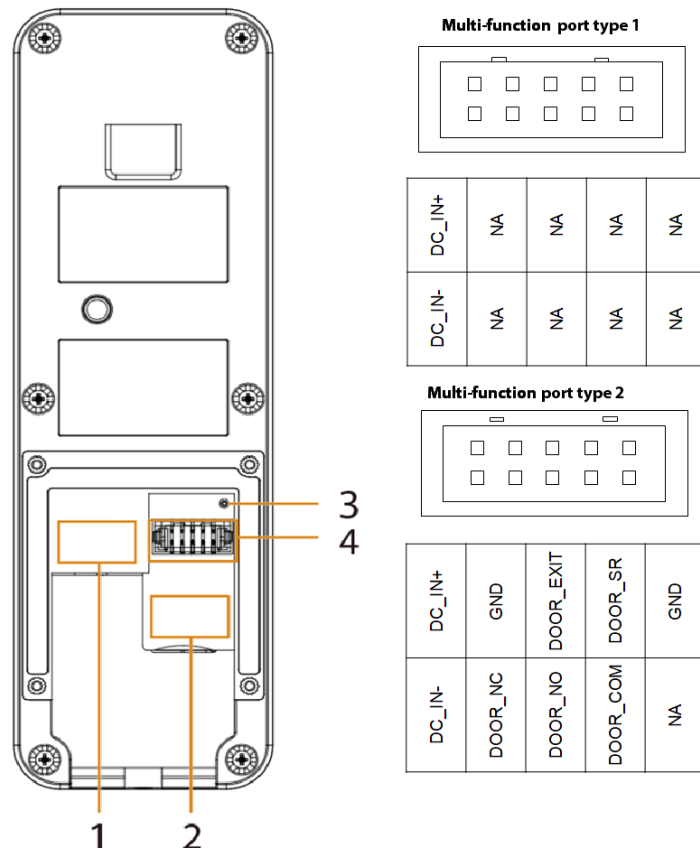

Table 1-4 Components

No.	Name	Function
1	Network port	Connects to the network.
2	SD card slot	Insert SD card so that data information such as images and videos can be stored.
3	Reset button	Press and hold the button for several seconds to reset to factory settings.
4	Multi-function port	<ul style="list-style-type: none"> <li>Type 1: The multi-function port only has a power input port to connect to power supply.</li> <li>Type2: The multi-function port includes a power input port and a door detector port.</li> </ul>

Figure 1-5 Rear panel (2)

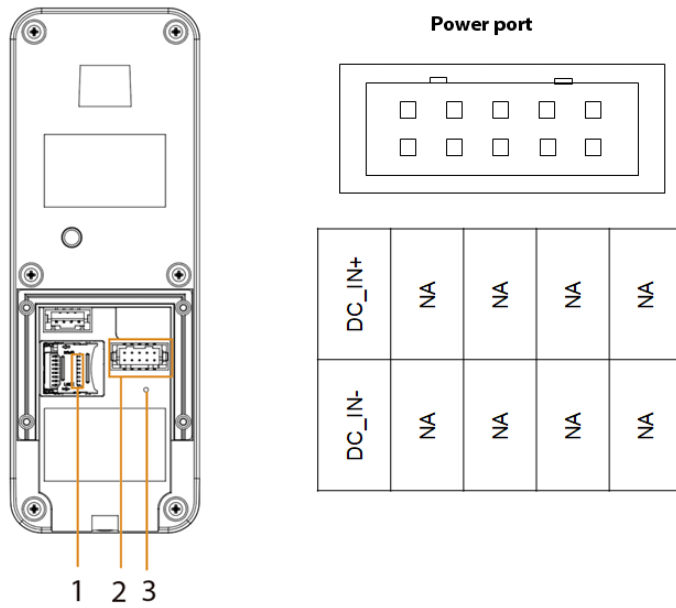

Table 1-5 Components

No.	Name	Function
1	SD card slot	Insert SD card so that data information such as images and videos can be stored.
2	Power port	Connects to the power supply.
3	Reset button	Press and hold the button for several seconds to reset to factory settings.

## 1.2.2 D Series

### 1.2.2.1 Front Panel

Figure 1-6 Front panel

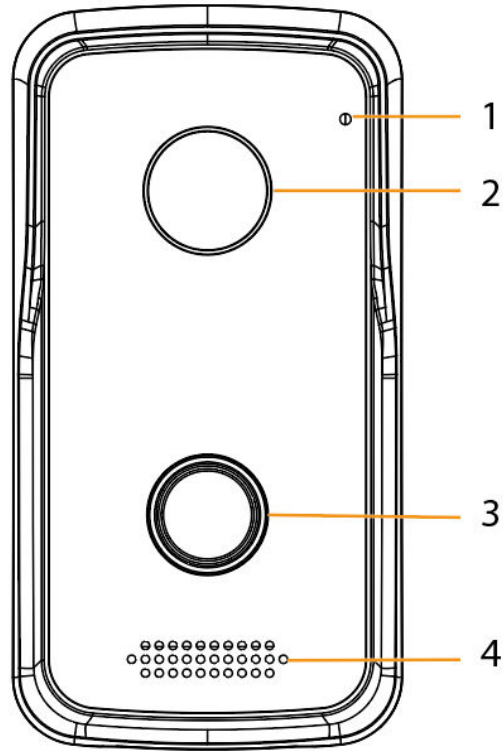

Table 1-6 Components

No.	Name	Function
1	MIC	Audio input.
2	Camera	Capture images or record videos for the VTO.
3	Call button	Call the VTH.
4	Speaker	Audio output.

### 1.2.2.2 Rear Panel

Figure 1-7 Rear panel

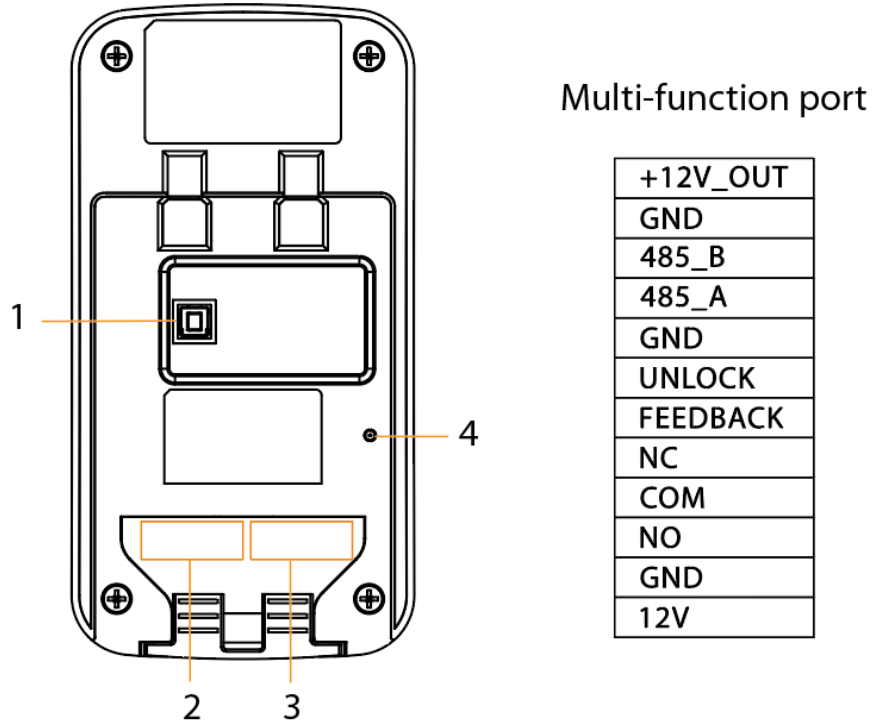

Table 1-7 Components

No.	Name	Function
1	Tamper button	<ul style="list-style-type: none"> <li>After the installed device is removed from the wall or other places, the device beeps and the alarm record will be generated.</li> <li>Within 5 minutes after the device is powered on, if you press the tamper button for 5 times in 8 seconds, the device beeps and deletes the account information. The alarm record will be generated.</li> </ul>
2	Multi-function ports	Alarm port, door detector port, 485 port, power port and more.
3	Network port	Connects to the network.
4	Reset button	Press and hold the button for several seconds to reset to factory settings.

## 1.2.3 G Series

### 1.2.3.1 Front Panel

Figure 1-8 Front panel

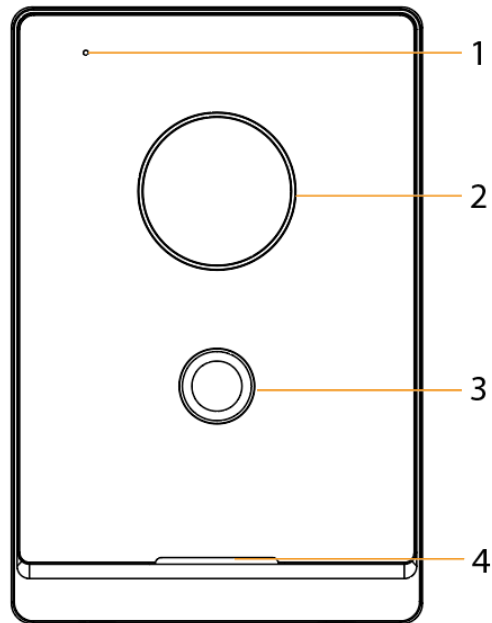

Table 1-8 Components

No.	Name	Function
1	MIC	Audio input.
2	Camera	Capture images or record videos for the VTO.
3	Call button	<p>Call the VTH.</p> <p>The button displays different colors in different statuses.</p> <ul style="list-style-type: none"> <li>● Standby: No light.</li> <li>● Call not answered: Solid green.</li> <li>● Call answered: Solid blue.</li> <li>● Unlock when the device is in standby status: Red.</li> <li>● Unlock when the call is not answered: Flashes green, yellow and then green.</li> <li>● Unlock after the call is answered: Flashes blue, pink and then blue.</li> <li>● Network disconnected: Green breathing light.</li> </ul>
4	Speaker	Audio output.



### 1.2.3.2 Rear Panel

Figure 1-9 Rear panel

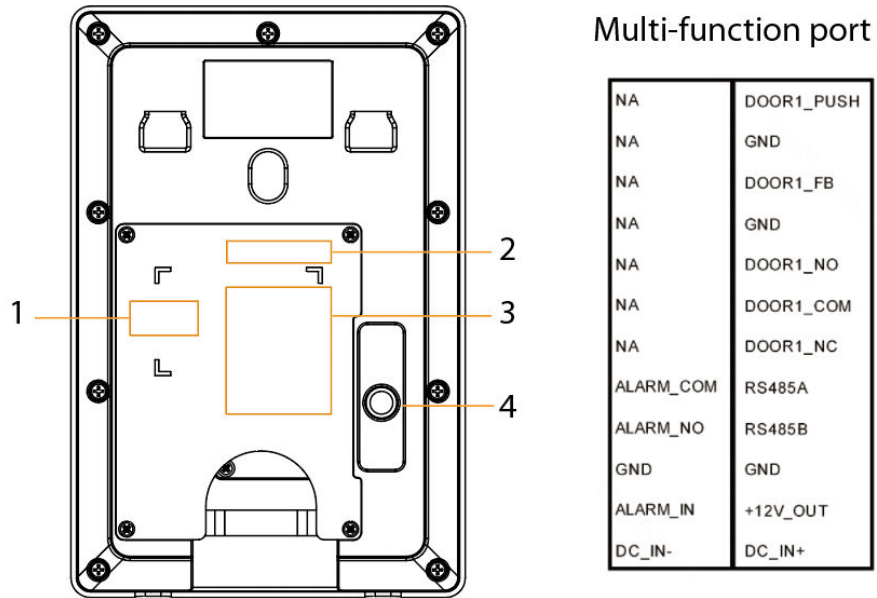

Table 1-9 Components

No.	Name	Function
1	Network port	Connects to the network.
2	Multi-function port	Alarm port, door detector port, 485 port, power port and more.
3	SD card slot	Insert SD card so that data information such as images and videos can be stored.
4	Tamper button	<ul style="list-style-type: none"> <li>After the installed device is removed from the wall or other places, the device beeps and the alarm record will be generated.</li> <li>Within 5 minutes after the device is powered on, if you press the tamper button for 5 times in 8 seconds, the device beeps and deletes the account information. The alarm record will be generated.</li> </ul>

### 1.2.4 E Series

### 1.2.4.1 Front Panel (3222E and 6222E)

Figure 1-10 Front panel

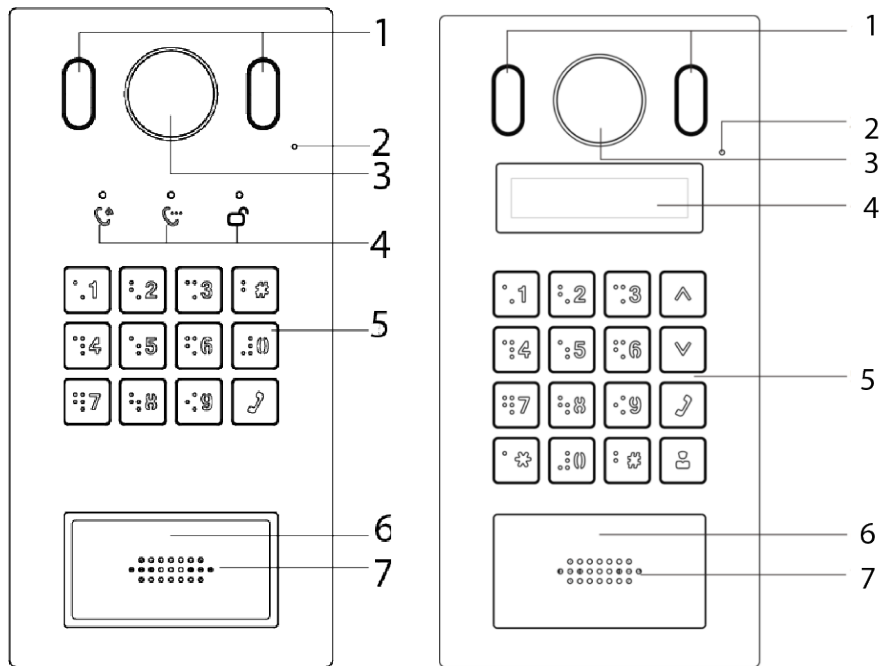

The panel on the left is the model of 3222E, and the one on the right is the model of 6222E.

Table 1-10 Front panel description

No.	Name	Description
1	Illuminator	Provides extra light for the camera when it is dark.
2	Microphone	Audio input.
3	Camera	Capture images or record videos for the VTO.
4	Indicators	Displays status on calling, talking and unlock.
5	Keypad	—
6	Card reading area	Swipe a card here to unlock the door.
7	Speaker	Audio output.

## 1.2.4.2 Rear Panel (3222E and 6222E)

Figure 1-11 Rear panel

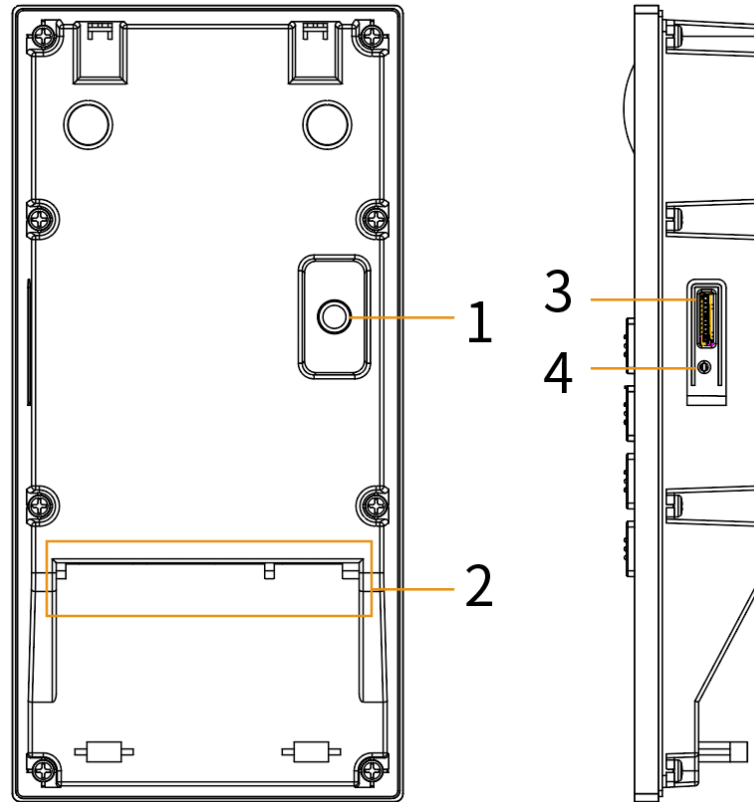

The rear panels of the model of 3222E and 6222E are the same.

Table 1-11 Rear panel description

No.	Name	Description
1	Anti-tampering switch	When the VTO is removed from the wall forcibly, an alarm will be triggered and the alarm information will be sent to management center.
2	Multi-function port	For details, see Figure 1-12 .
3	SD card slot	Plug in the SD card.
4	Reset button	Press and hold it for 10 seconds to reset all settings.

Figure 1-12 Multi-function port

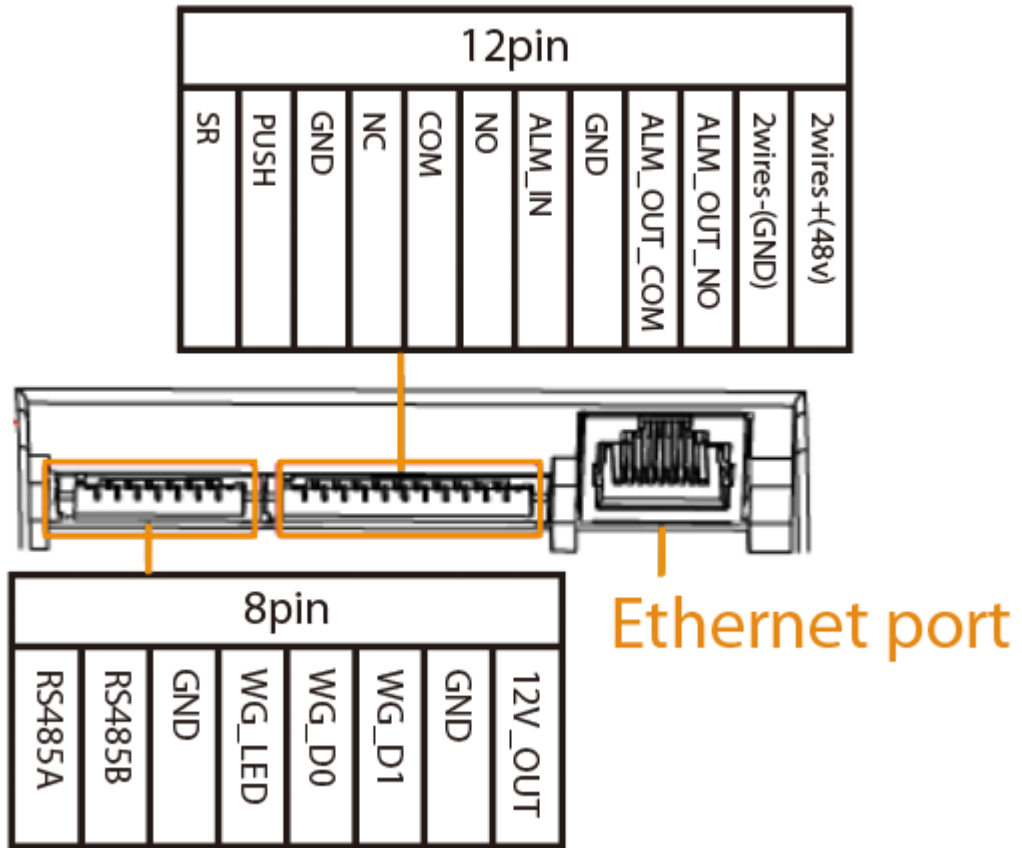

### 1.2.4.3 Front Panel (2101E)

Figure 1-13 Front panel

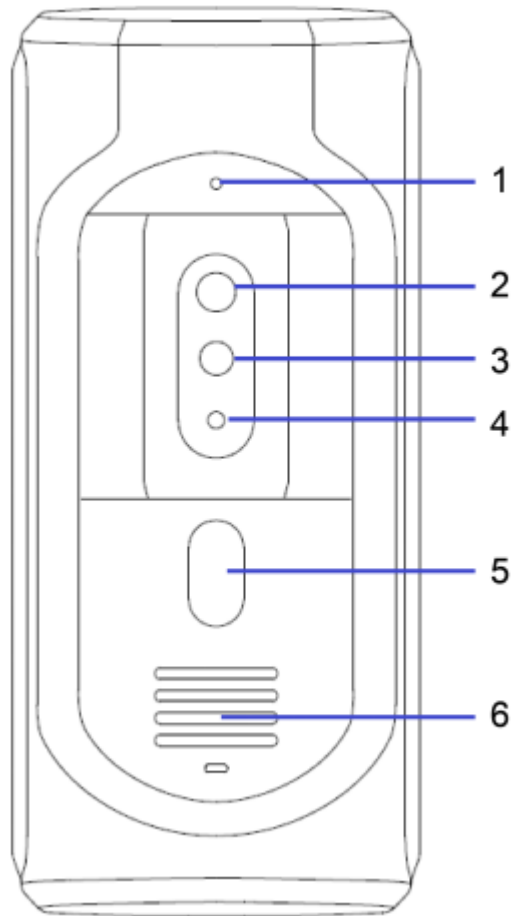

Table 1-12 Front panel description

No.	Name	Description
1	Microphone	—
2	Camera	—
3	IR illumination light	Provides extra IR light for the camera when it is dark.
4	Light sensor	Detects ambient lighting condition.
5	Call button	Call VTHs or the management center.
6	Speaker	—

### 1.2.4.4 Rear Panel (2101E)

Figure 1-14 Rear panel

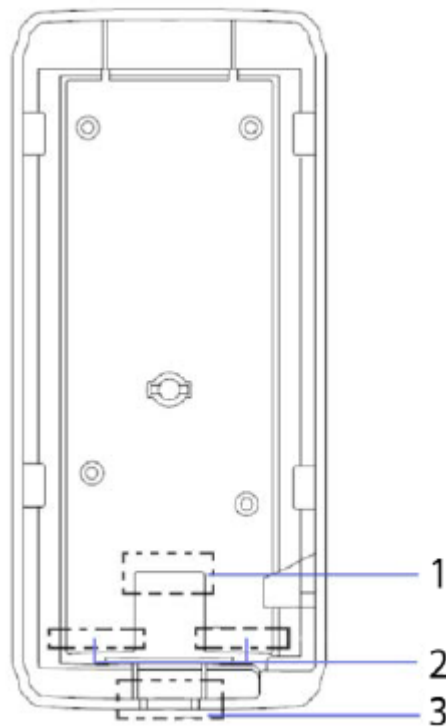

Table 1-13 Rear panel description

No.	Name	Description
1	Network port	Connects to the network cable.
2	RS-485 ports	See the figure and the table below.
3	Cable outlet	Thread the cables here.

Figure 1-15 Cable connection

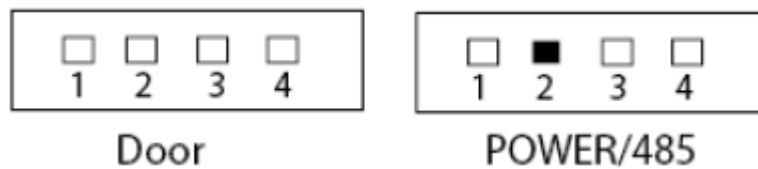

Table 1-14 Port description

DOOR		POWER/485	
No.	Name	No.	Name
1	NO	1	+12
2	NC	2	GND
3	COM	3	RS-485A
4	ALARM IN or Unlock (default)	4	RS-485B

## 1.2.5 F Series

### 1.2.5.1 Front Panel

Figure 1-16 Front panel

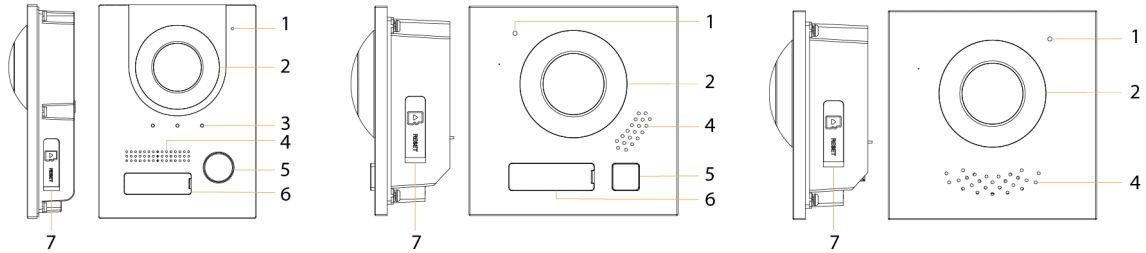

Table 1-15 Front panel description

No.	Name	Description
1	Microphone	Audio input.
2	Camera	Capture images or record videos for the VTO.
3	Indicators	Display status on calling, talking and unlock.
4	Speaker	Audio output.
5	Call button	Call the VTH and the management center.
6	Nameplate	Displays the custom information.
7	Card slot and reset button	<ul style="list-style-type: none"> <li>● Insert SD card so that data information such as images and videos can be stored.</li> <li>● Press and hold the button for several seconds to reset to factory settings.</li> </ul>

### 1.2.5.2 Rear Panel

Figure 1-17 Rear panel

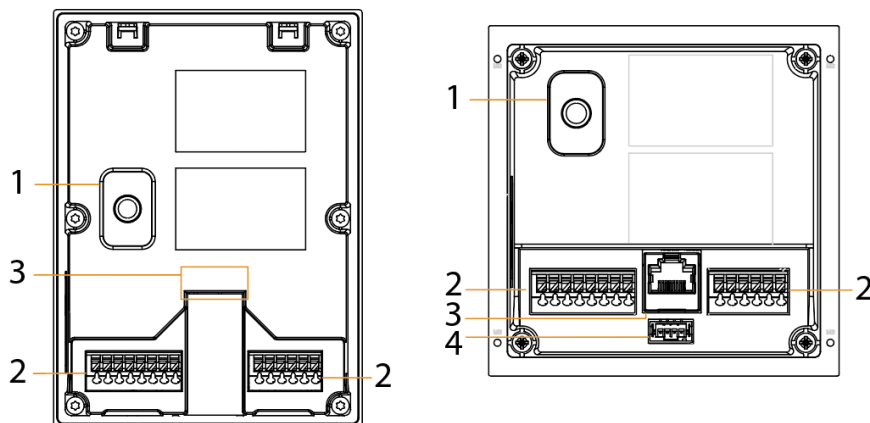

Table 1-16 Rear panel description

No.	Name	Function
1	Tamper button	<ul style="list-style-type: none"> <li>After the installed device is removed from the wall or other places, the device beeps and the alarm record will be generated.</li> <li>Within 5 minutes after the device is powered on, if you press the tamper button for 5 times in 8 seconds, the device beeps and deletes the account information. The alarm record will be generated.</li> </ul>
2	Multi-function ports	Alarm port, door detector port, 485 port, power port and more.
3	Network port	Connect to the network.
4	Cascade connection port	Connect to other modules.

Figure 1-18 Multi-function ports

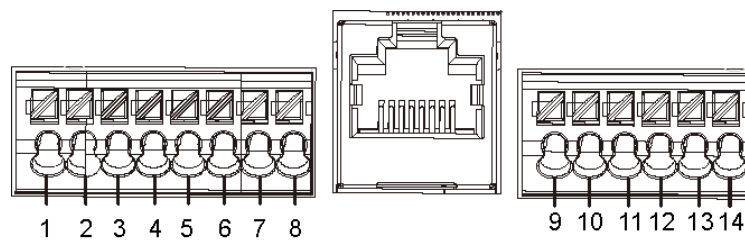

Table 1-17 Port description

No.	Description	No.	Description
1	GND	8	<ul style="list-style-type: none"> <li>2wires-(GND) for a digital 2-wire camera module</li> <li>GND for a full digital camera module</li> </ul>
2	+12V_OUT	9	DOOR_BUTTON
3	RS-485_B	10	DOOR_FEEDBACK
4	RS-485_A	11	GND
5	ALARM_NO	12	DOOR_NC
6	ALARM_COM	13	DOOR_COM
7	<ul style="list-style-type: none"> <li>2wires+(48V) for a digital 2-wire camera module</li> <li>12 V_IN for a full digital camera module</li> </ul>	14	DOOR_NO



### 1.2.5.3 Indicator Module

Figure 1-19 Front panel

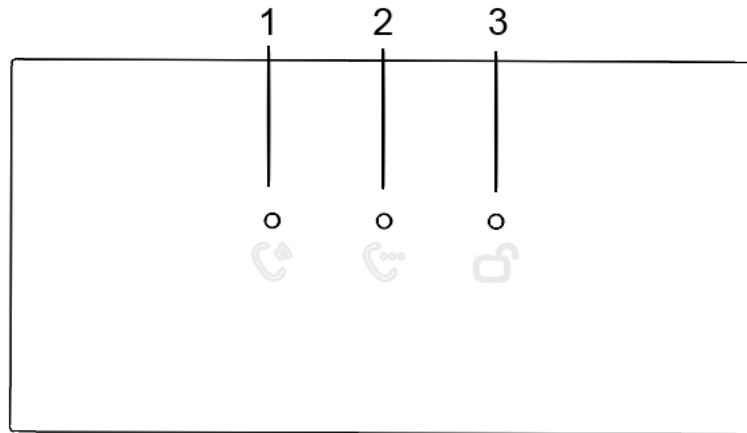

Table 1-18 Front panel description

No.	Name	Description
1	Call indicator	Activity status.
2	Talk indicator	
3	Unlock indicator	

Figure 1-20 Rear panel

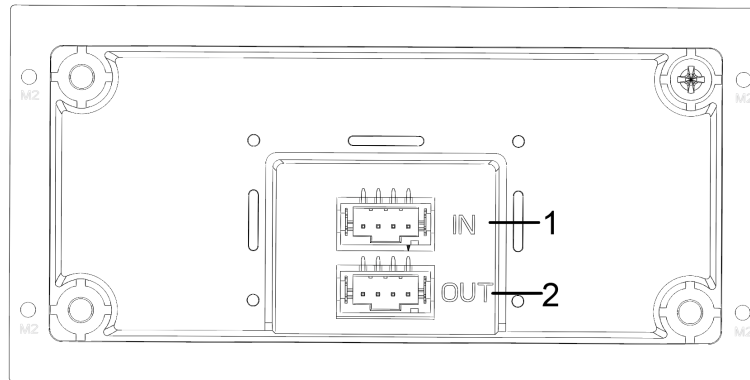

Table 1-19 Rear panel description

No.	Name	Description
1	Cascade input	Connect to other modules.
2	Cascade output	

### 1.2.5.4 Button Module

#### 1-button module, 2-button module, and 5-button module

One-button module, two-button module, and five-button module are available with the same function. Here we take the five-button module as an example.

Figure 1-21 Front panel of the five-button module

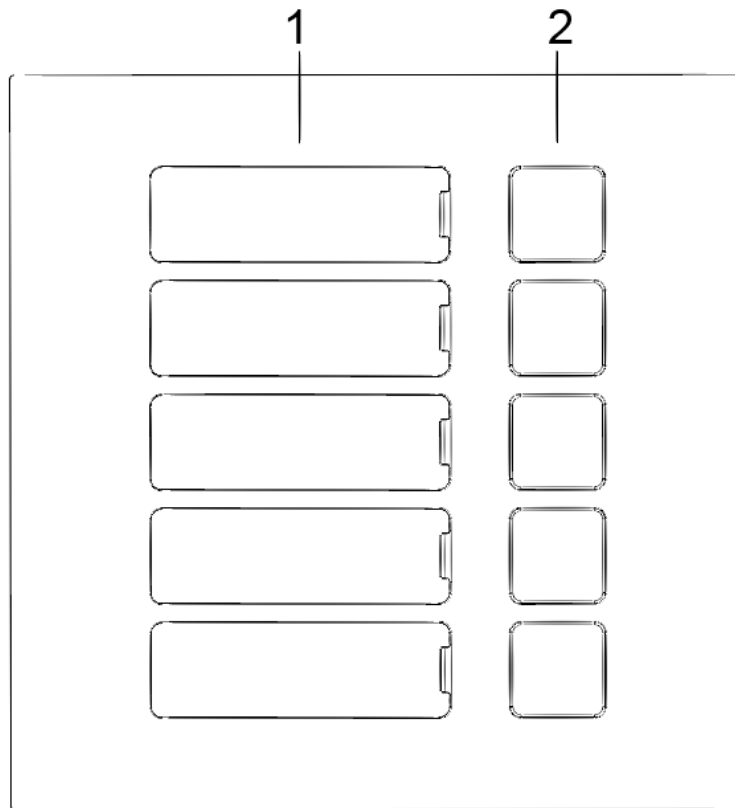

Table 1-20 Front panel description

No.	Name	Description
1	User directory	Put name cards here.
2	Call buttons	Call other VTHs or the management center.

Figure 1-22 Rear panel of the five-button module

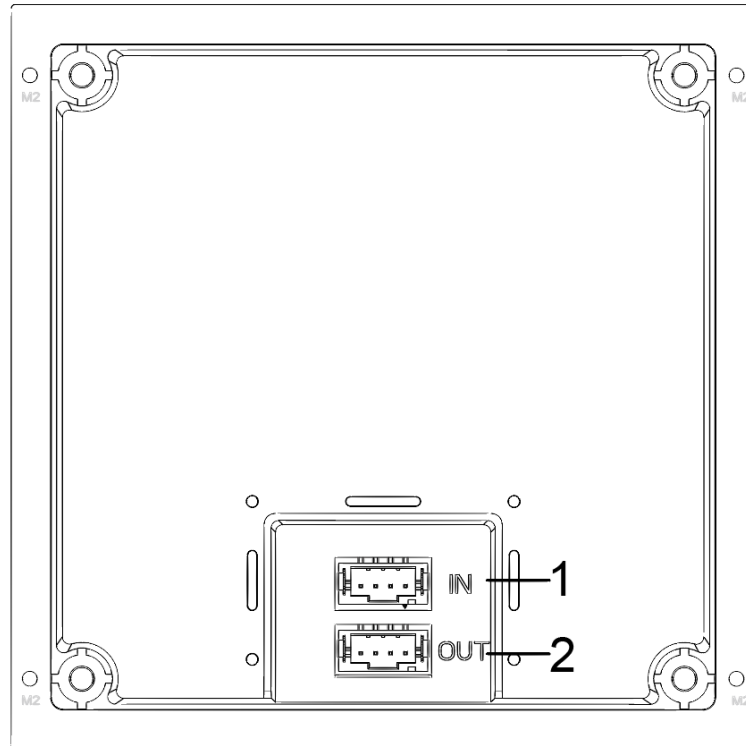

Table 1-21 Rear panel description

No.	Name	Description
1	Cascade input	Connect to other modules.
2	Cascade output	

## 2-button module, 4-button module, and 10-button module

Two-button module, four-button module, and ten-button module are available with the same function. Here we take the ten-button module as an example.

Figure 1-23 Front panel of the ten-button module

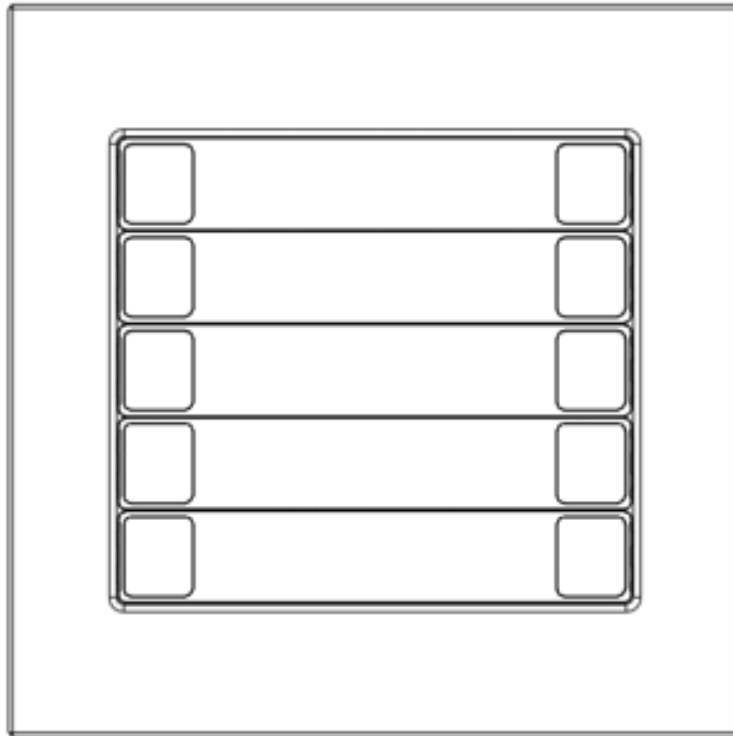

Figure 1-24 Rear panel of the ten-button module

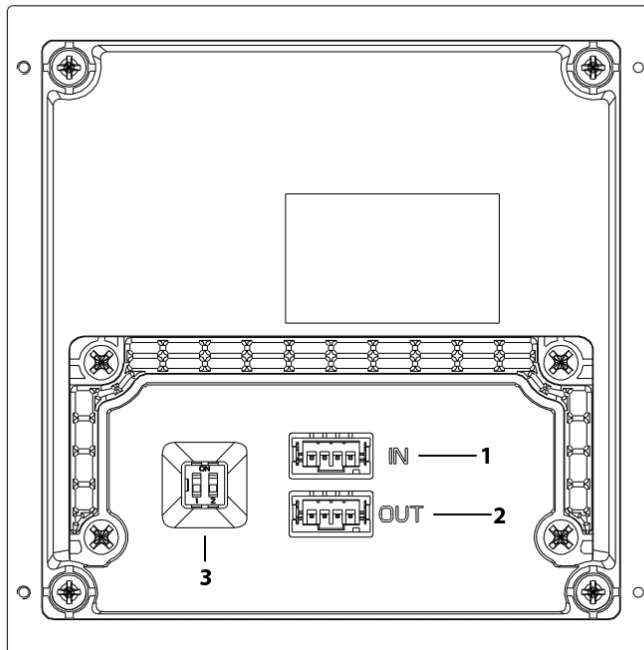



Table 1-22 Rear panel description

No.	Name	Description
1	Cascade input	Connect to other modules.
2	Cascade output	

No.	Name	Description
3	Mode switch	<ul style="list-style-type: none"> <li>• Switch between single-column buttons and two-column buttons.</li> <li>• The first DIP switch on the left turns to <b>ON</b> indicates the single-column buttons, while to <b>1</b> indicates the two-column buttons.</li> <li>• It takes effect after the main VTO is restarted.</li> <li>• Flipping up or down the second (from left to right) DIP switch has no effect.</li> </ul> <p> If you want to change two-column buttons mode into single-column buttons mode, take the single-column buttons accessory from the package to replace it. For information about room number configurations on the WEB, see "6.6 Layout".</p>

### 1.2.5.5 Keyboard Module (with Braille)



The rear panel of keyboard module is the same as the button module.

Figure 1-25 Keyboard module

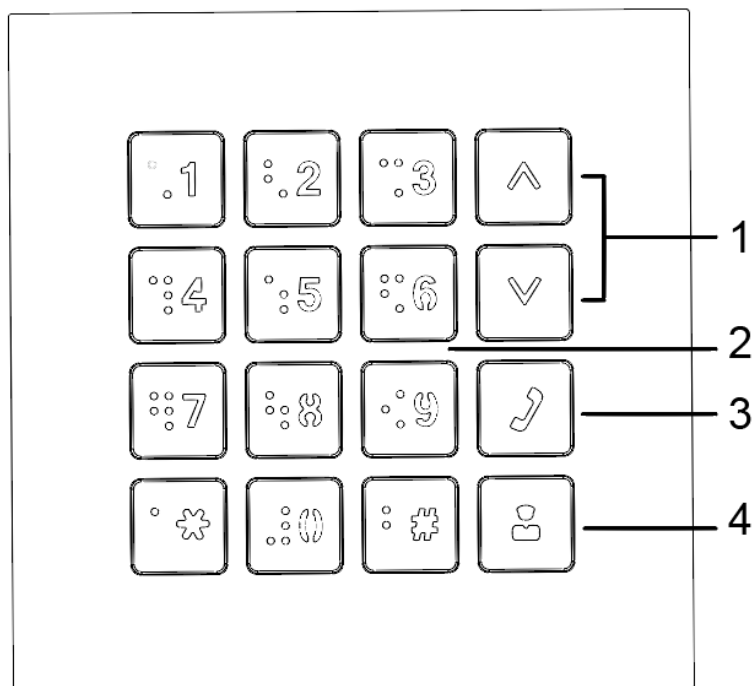

Table 1-23 Keyboard module description

No.	Name	Description
1	Selection	Tap the button to select the contact.
2	Numbers	Enter password or VTH numbers.
3	Call	Call according to the numbers.
4	Call management center	Call the management center.

### 1.2.5.6 Card Module

There are 2 types of the card module. Select from the ID card module and IC card module as needed.



The rear panel of card module is the same as the button module.

Figure 1-26 Card module



### 1.2.5.7 Fingerprint Module

Collects and verifies fingerprints.



- The rear panels of fingerprint module and button module have different port positions, but port functions are the same.
- When there is a fingerprint module accessed and you want to add a new fingerprint module, clear the fingerprint information on the original fingerprint module.

Figure 1-27 Fingerprint module

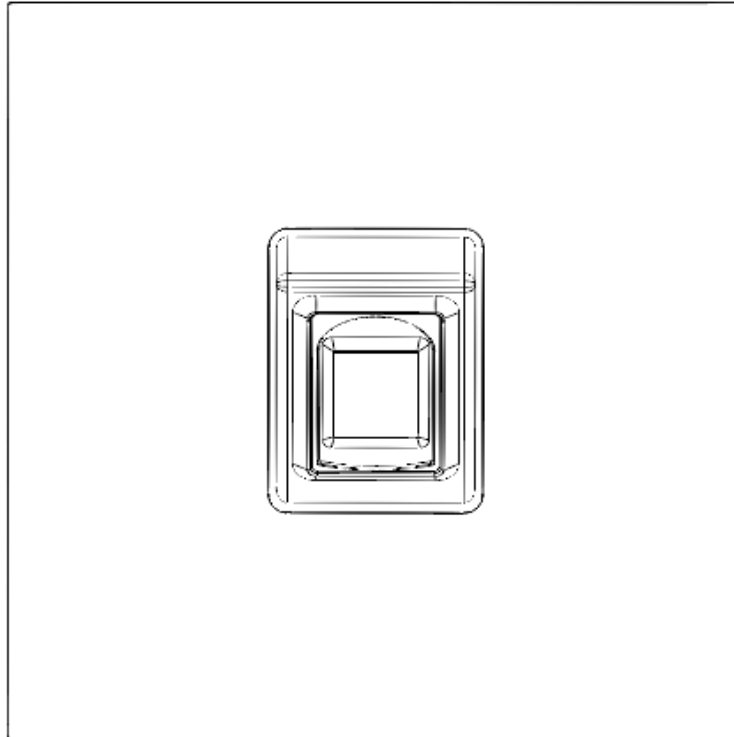

### 1.2.5.8 Display Module

Displays user information.



Rear panels of display module and button module have different port positions, but port functions are the same.

Figure 1-28 Display module

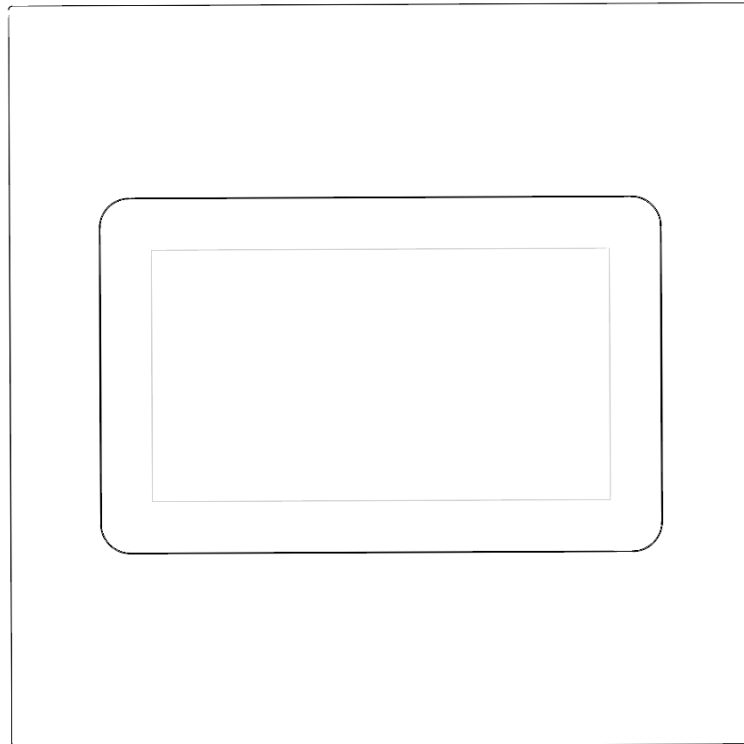

### 1.2.5.9 Information Module

Displays room number and guest message.

Figure 1-29 Information module

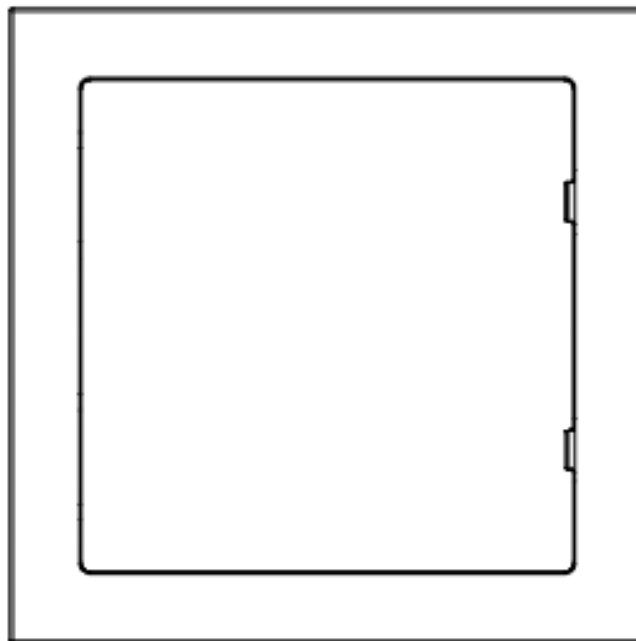



### 1.2.5.10 Blank Module

For a better appearance, use the blank module if there is an extra space while putting up modules together.

Figure 1-30 Blank module

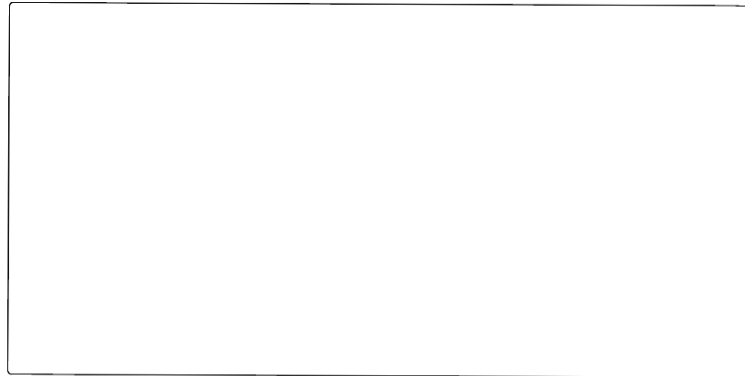

### 1.2.5.11 Cascade Connection

Cascade connection is needed for all the modules to work together.

Figure 1-31 Cascade connection example

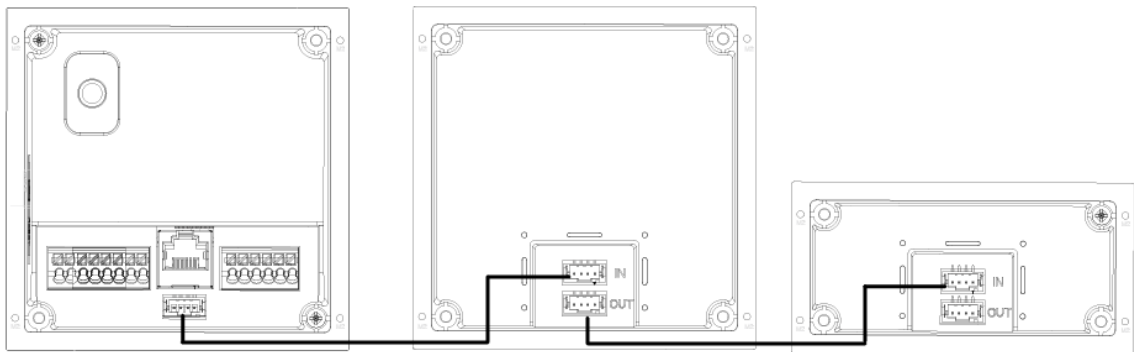

## 1.3 Button Model

### 1.3.1 Front Panel

Figure 1-32 Front panel

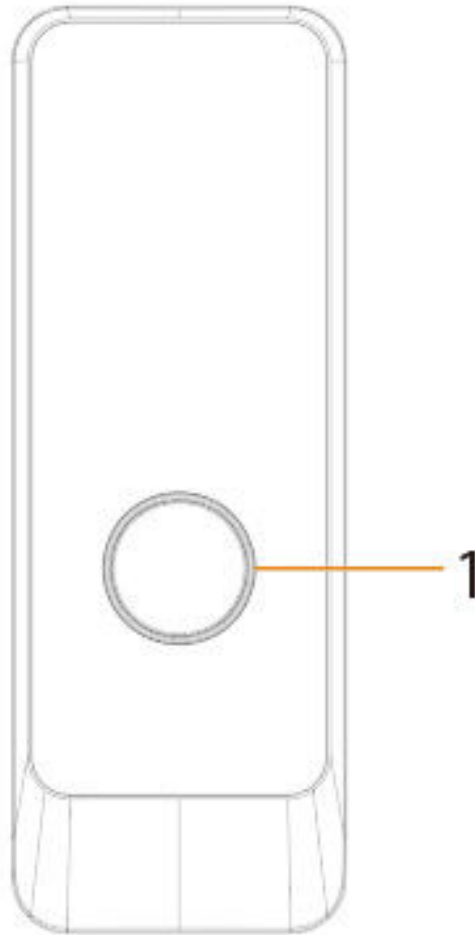

Table 1-24 Components

No.	Name	Function
1	Press button	The button model can be connected to the VTH. Press the button on the model and the VTH receives an alarm signal.

## 1.3.2 Rear Panel

Figure 1-33 Rear panel

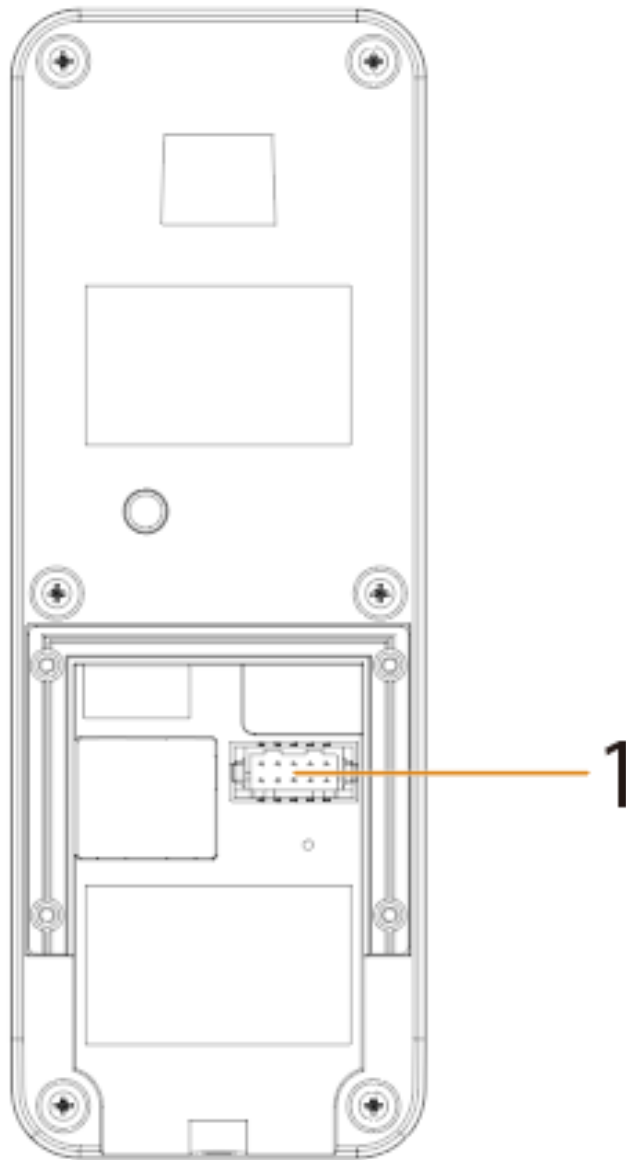
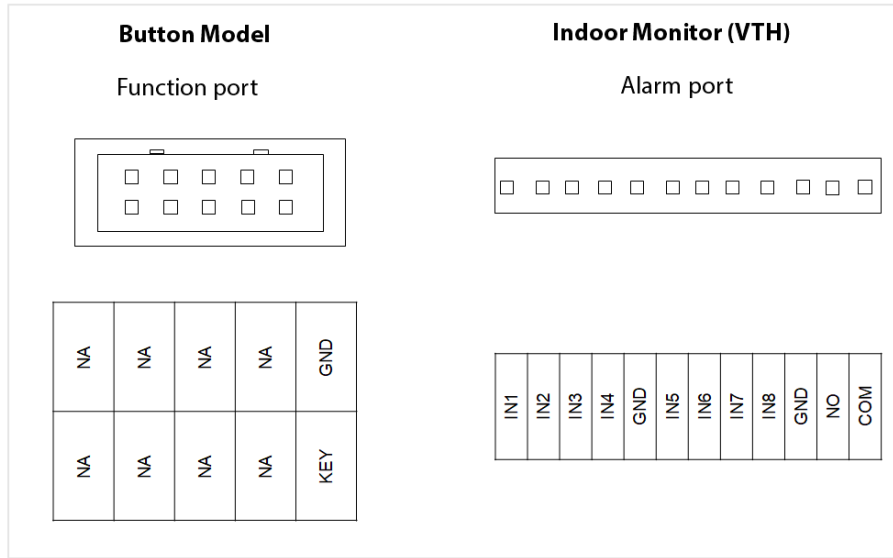

Table 1-25 Components

No.	Name	Function
1	Multi-function port	Used for alarm input.

Figure 1-34 Cable connection



Connect the KEY port of the button model to any one of the alarm input ports of the indoor monitor (VTH) with a cable thread. After that, tap **Setting** > **Alarm** > **Wired Zone** on the VTH and set the **Type** of the alarm input port you chose to connect to the KEY port as **Doorbell**.

## 2 Initializing the VTO

### 2.1 Web

For first-time login, you need to initialize the VTO.

#### Procedure

Step 1 Power on the VTO.

Step 2 Go to the default IP address (192.168.1.108) of the VTO.



Make sure that the IP address of your PC is on the same network segment as the VTO.

Step 3 On the **Device Init** page, enter and confirm the password, and then click **Next**.



The password must consist of 8–32 non-blank characters and contain at least two types of the following characters: Uppercase, lowercase, numbers, and special characters (excluding ' " ; : &).

Step 4 Select the **Email** checkbox and enter an email address for resetting password.

Step 5 Click **Next**.

Step 6 Click **OK** to go to the login page.

Step 7 Enter the username (admin by default) and password to log in to the webpage.

### 2.2 DMSS APP

If your model only supports Wi-Fi connection to the network, you can only initialize the VTO on the DMSS app. For detailed operation of the app, refer to its user's manual.

#### Prerequisites

You have downloaded the DMSS in the APP Store (iOS) or Google Play (Android), and have created an account and logged in to the app.

#### Procedure

Step 1 Power on the VTO.

Step 2 Enable hotspot on the VTO through pressing and holding the call button on the VTO until you heard the voice prompt.



The hotspot function is to enable you connect the VTO to the network through **AP configuration** on the app.

Step 3 Add the VTO to the DMSS app.

1. On the **Home** screen, tap , and then select **SN/Scan**.
2. Add a VTO.
3. You can add through scanning the QR code at the rear panel of the VTO.
4. The SN number of the VTO appears automatically, and then tap **Next**.
5. Select device type as **VTO**, and then the device information appears.
6. Tap **View Reasons**.

Figure 2-1 Add VTO to DMSS



7. Configure network by switch networking to **AP Configuration** , and then tap **Next**.
8. Connect your phone to the hotspot you just enabled on the VTO.

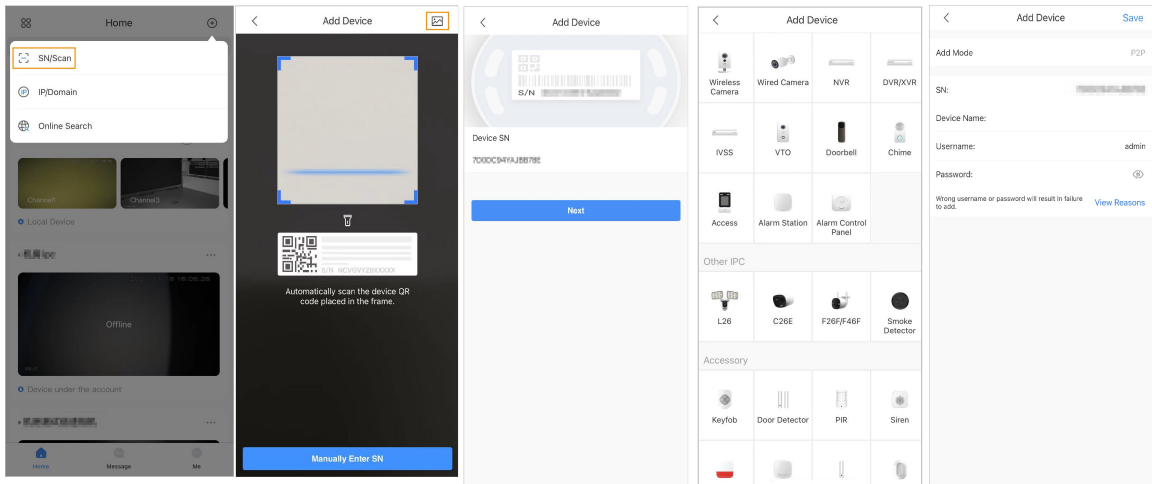

- The hotspot name is the SN number of your VTO.
- The current page will move on to the next step automatically after connection.

Figure 2-2 AP configuration

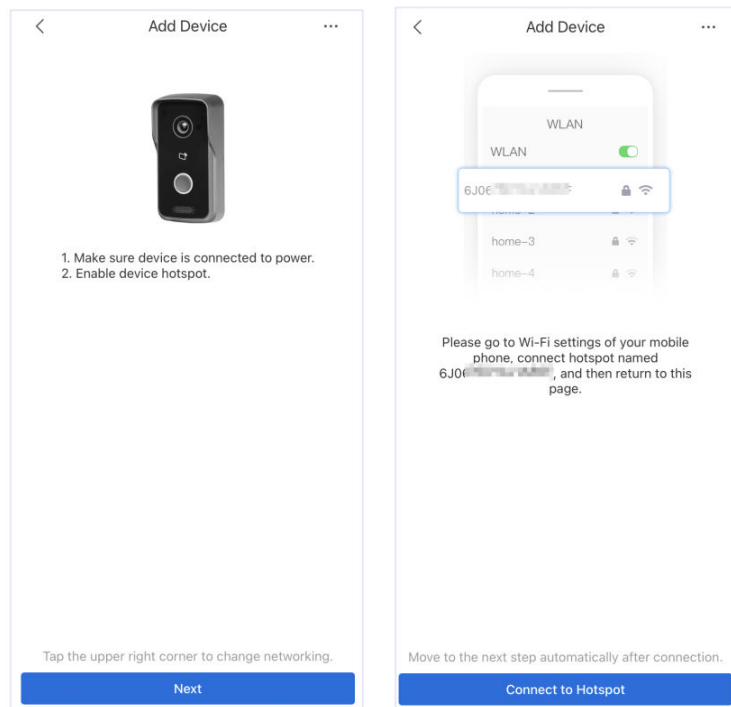

**Step 4** Complete initialization based on instructions on the app.

1. Enter the password you planned for the VTO, and confirm it, and then tap **Next**.
2. Select **Cloud Access** and **Auto-check**, and then tap **OK**.

The initialization process is completed.

Figure 2-3 Initialization

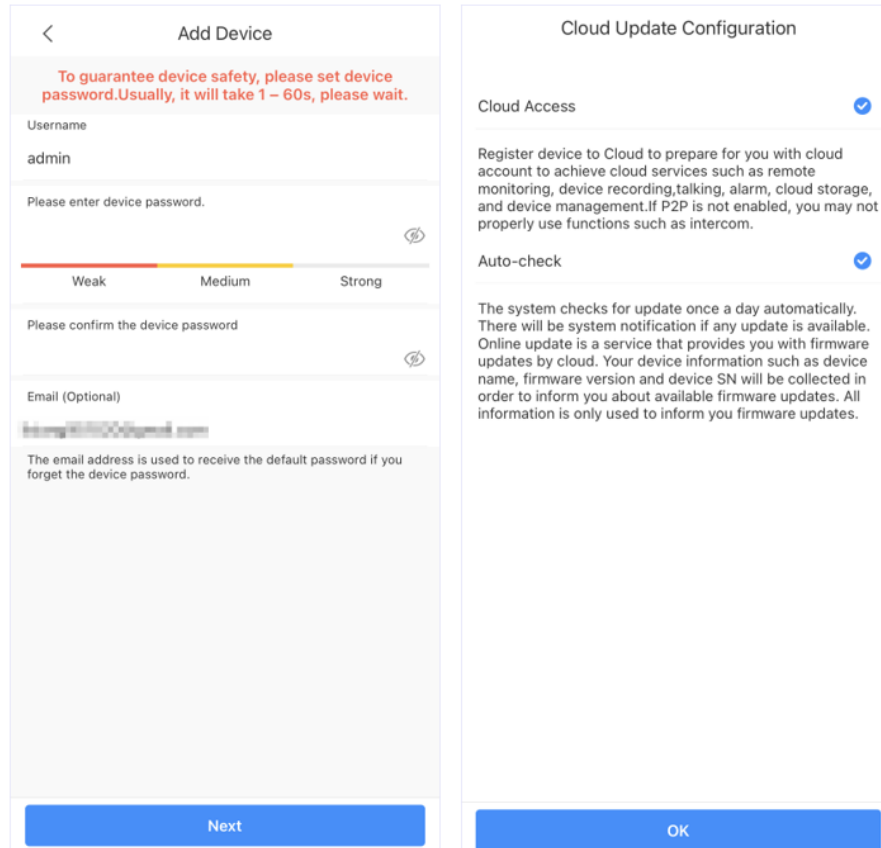

- Step 5** Connect the VTO to the network through Wi-Fi.
1. Select an available Wi-Fi.
  2. Enter the password and tap **Next**. Wait for the VTO to connect to the router.

Figure 2-4 Wi-Fi connection

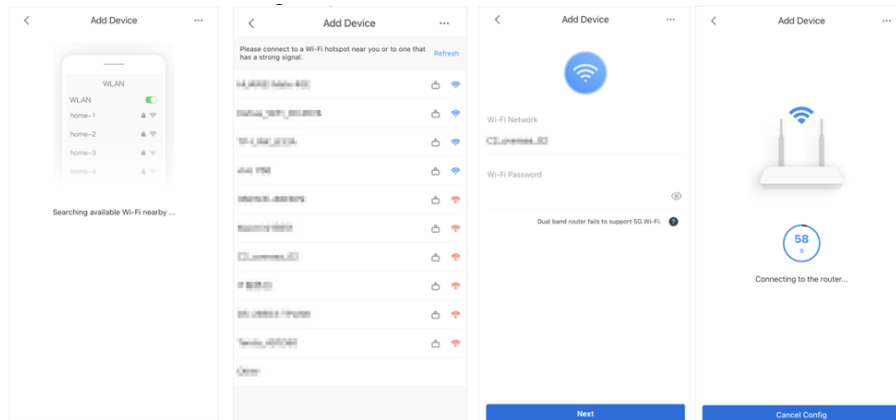

- Step 6** Configure device name, and then tap **Save**.

Figure 2-5 Configure device name

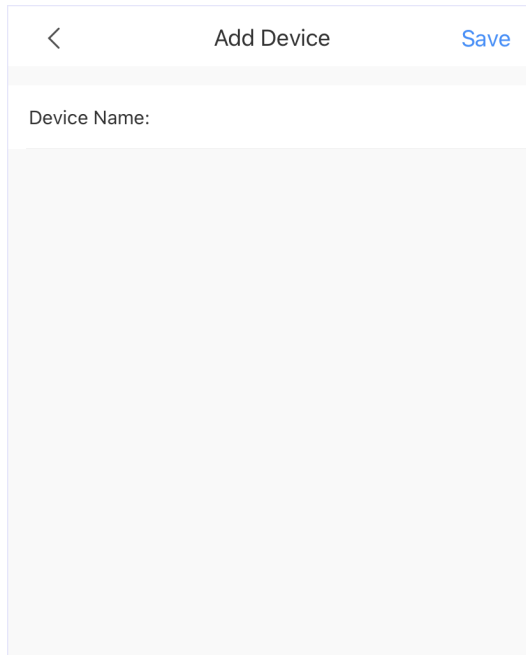

Step 7 View monitoring video from the camera on the VTO.

Figure 2-6 Monitor

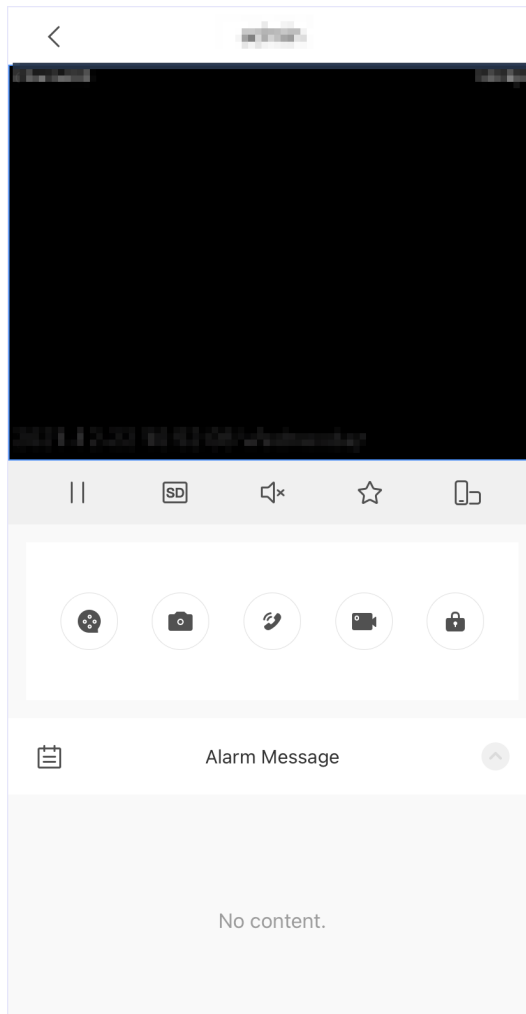



# 3 Login and Resetting Password

## 3.1 Login

Before login, make sure that the computer is on the same network segment as the VTO.

### Procedure

Step 1 Go to the IP address of the VTO in the browser.



For first-time login, enter the default IP (192.168.1.108). If you have multiple VTOs, we recommend that you change the default IP address to avoid conflict.

Step 2 Enter **admin** as the username, and enter the password you set during initialization, and then click **Login**.

Figure 3-1 Login

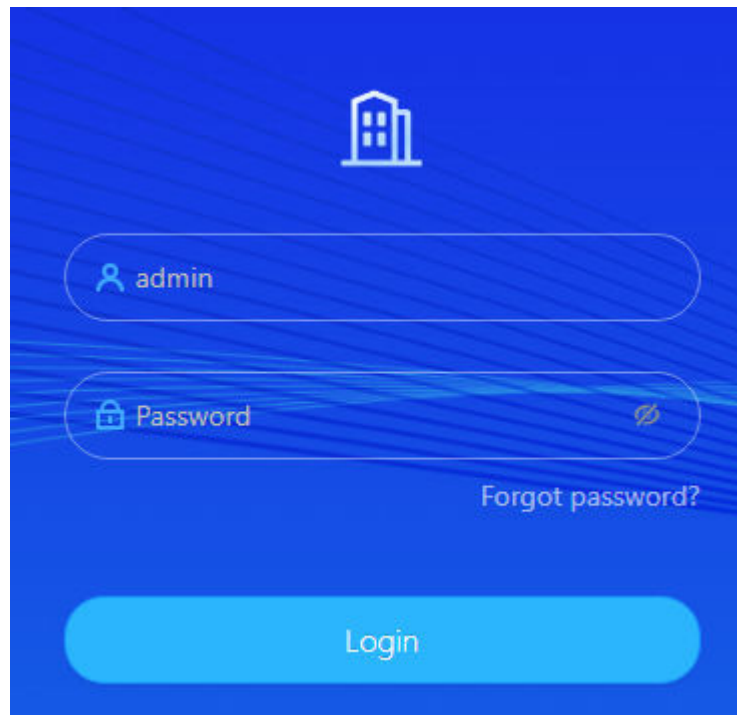

## 3.2 Resetting Password

### Procedure

Step 1 On the login page, click **Forgot Password?**, and then click **Next**.

Step 2 Scan the QR code, and then you will get a string of numbers and letters.

Step 3 Send the string to the email account displayed on the page, and then the security code will be sent to the email address configured during initialization.

Step 4 Enter the security code in the input box, and then click **Next**.



- If you did not set an email address during initialization, contact your supplier or customer service for help.

- The security code will be valid only for 24 hours upon receipt.
- If you enter the wrong security code for 5 consecutive times, your account will be locked for 5 minutes.

Step 5 Enter and confirm the new password, and then click **OK**.

# 4 Home Page

Figure 4-1 Home page

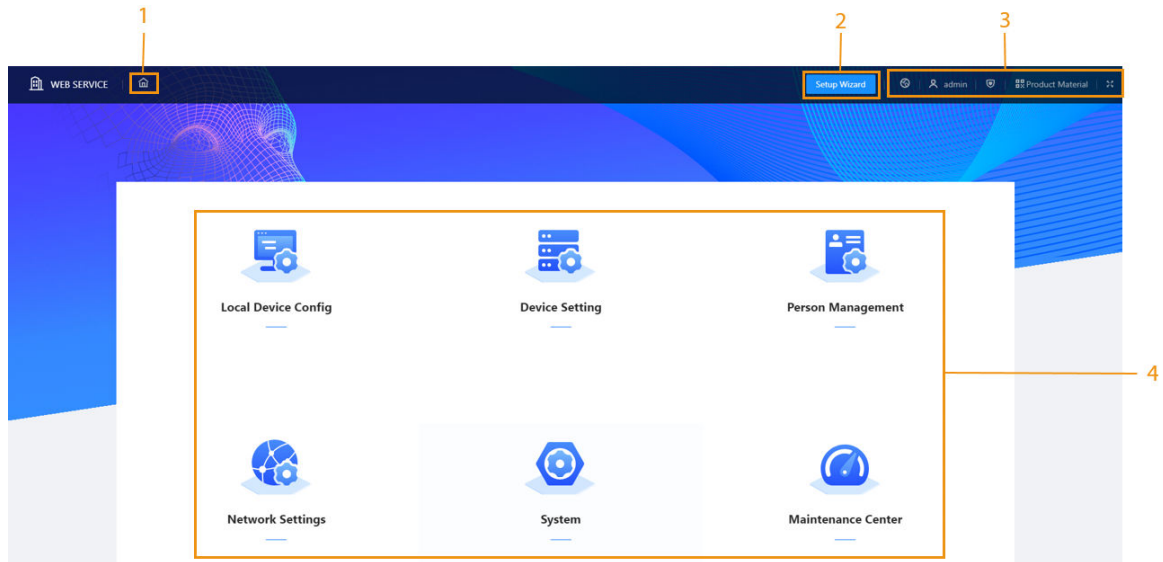







Table 4-1 Home page introduction

No.	Function	Description
1	Home button	Go back to the home page.
2	Setup Wizard	Configure the VTO SIP server.
3	Navigation bar	<ul style="list-style-type: none"> <li>: Change language of the webpage of the VTO.</li> <li>: Change password, log out of the current device, restart the system, and restore the device to factory settings.</li> <li>: View and configure the security settings.</li> <li>: Scan the QR code to get the product material.</li> <li>: View the webpage in full screen mode.</li> </ul>
4	VTO function	Different function areas of the VTO.

# 5 Setup Wizard

Through the setup wizard, you can finish the process of adding VTO/VTH and specific any VTO as the SIP server. You can also cancel its status of working as a SIP server.

## 5.1 Setting as SIP Server

Set the VTO as the SIP server.

### Prerequisites

You have added VTOs on the webpage. If not, you can add them in **Set as SIP Server** page or in the **Device Setting** section.

### Procedure

Step 1 Log in to the webpage of the VTO.

Step 2 Select **Setup Wizard** > **Set as SIP Server**, and then click **Next**.

Figure 5-1 Set as SIP server

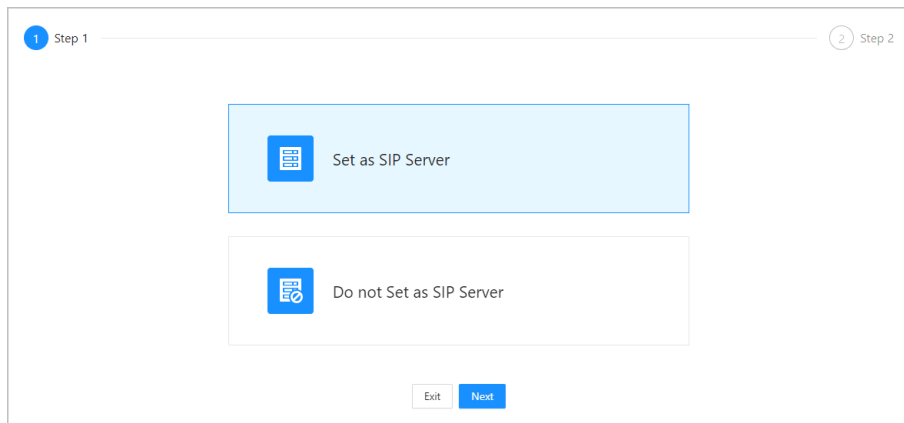

Step 3 Select the VTO to be set as the SIP server, and then click **OK**.

You can also click **Add** to add VTOs if you have not had one to work as the SIP server.

Figure 5-2 Select the SIP server

Device Type	SIP No.	IP Address	Online Status	Operation
<input type="checkbox"/> VTO	8001	127.0.0.1	● Online	
<input type="checkbox"/> VTH	990140		● Offline	
<input type="checkbox"/> VTH	990141		● Offline	
<input type="checkbox"/> VTH	990142		● Offline	
<input type="checkbox"/> VTH	990143		● Offline	
<input type="checkbox"/> VTH	990144		● Offline	
<input type="checkbox"/> VTH	990145		● Offline	
<input type="checkbox"/> VTH	990146		● Offline	
<input type="checkbox"/> VTH	990147		● Offline	
<input type="checkbox"/> VTH	990148		● Offline	

## 5.2 Not Setting as SIP Server

If you want to change the SIP server, you need to remove the current one from the list.

### Procedure

Step 1 Log in to the webpage of the VTO.

Step 2 Select **Setup Wizard** > **Do not Set as SIP Server**, and then click **Next**.

Figure 5-3 Do not set as SIP server

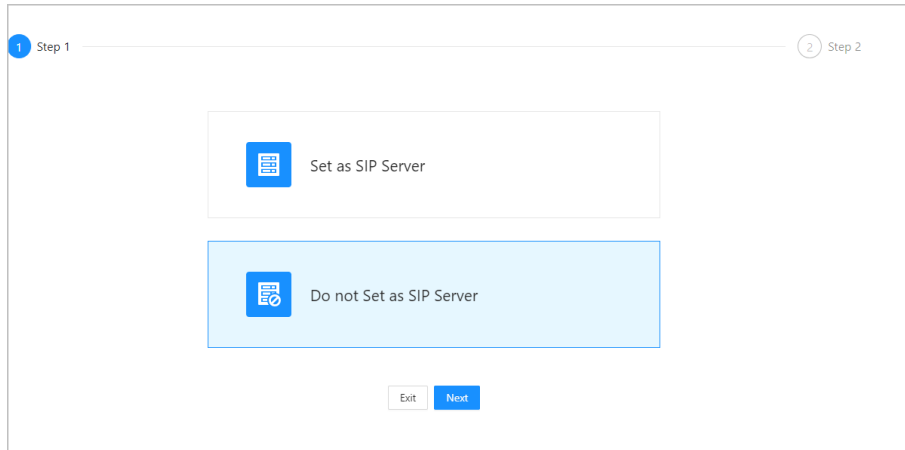

Step 3 Configure the information of the VTO that you do not want to set as SIP server, and then click **OK**.

Figure 5-4 Configure information

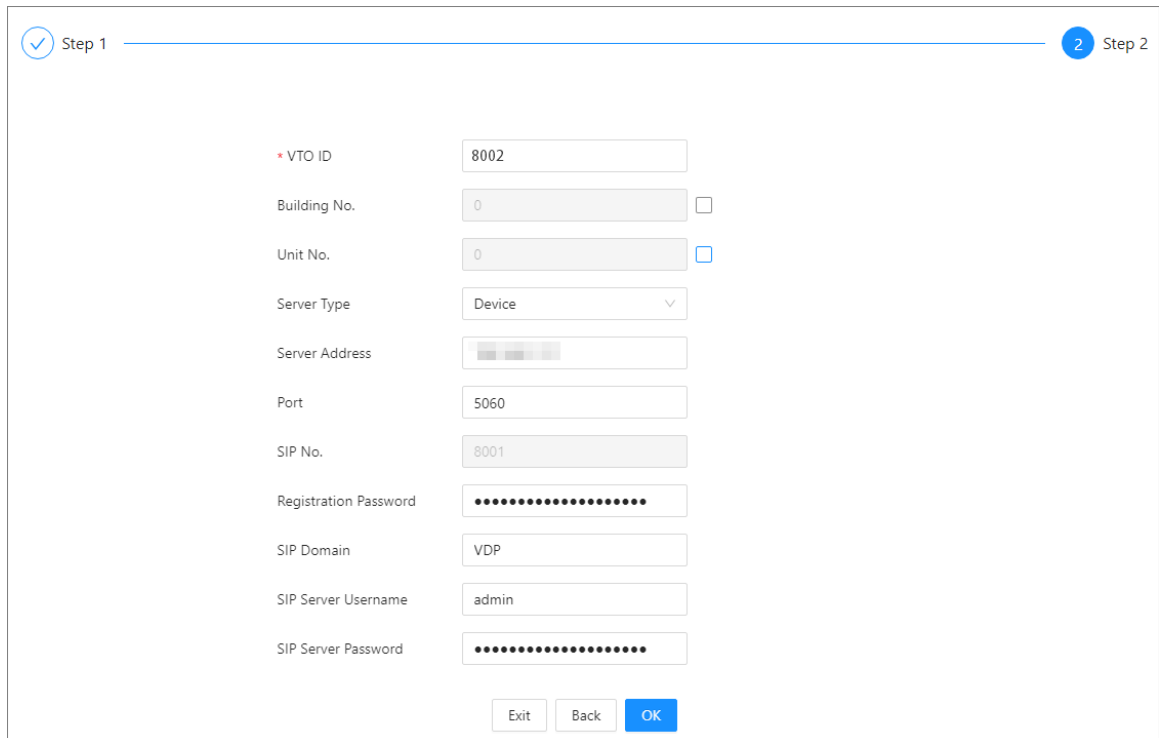
The screenshot shows a configuration form for a VTO. The form is titled 'Step 1' and has 'Step 2' disabled. The fields are: 'VTO ID' (8002), 'Building No.' (0), 'Unit No.' (0), 'Server Type' (Device), 'Server Address' (blurred), 'Port' (5060), 'SIP No.' (8001), 'Registration Password' (masked with dots), 'SIP Domain' (VDP), 'SIP Server Username' (admin), and 'SIP Server Password' (masked with dots). At the bottom, there are 'Exit', 'Back', and 'OK' buttons.

# 6 Local Device Configuration

This chapter introduces the detailed configuration of the VTO.



Slight differences might be found in different models.

## 6.1 Basic Settings

Configure basic settings of the device.

### 6.1.1 Villa Door Station

#### Procedure

- Step 1 Select **Local Device Config** > **Basic Settings**.
- Step 2 Configure the parameters.

Figure 6-1 Basic settings (villa station)

### Local Device Config

Device Type	<input type="text" value="Villa Station"/>
Device Name	<input type="text" value="11111111"/>
Villa Room No.	<input type="text" value="101"/>
VTO ID	<input type="text" value="8001"/>
Group Call	<input checked="" type="checkbox"/>
Management Center	<input type="text" value="888888"/>
Call Period	<input type="button" value="Setting"/>

---

### Calling by Period Mode

Enable	<input type="checkbox"/>
--------	--------------------------

---

### Functions

Storage Method	<input type="text" value="SD Card"/>
SD Card Usage	<div style="border: 1px solid #ccc; padding: 2px;">0M/0M</div>
	<input type="button" value="Format SD Card"/> <span style="border: 1px solid #add8e6; padding: 2px;">! If the SD card cannot be recognized, you can format it.</span>
Auto Capture while Unlocking	<input checked="" type="checkbox"/>
Auto Capture during Call	<input checked="" type="checkbox"/>
Upload Messages and Videos	<input checked="" type="checkbox"/>
Auto Record while Calling	<input checked="" type="checkbox"/>
	<div style="border: 1px solid #add8e6; padding: 2px;">! Please regularly perform backups to avoid data loss.</div>

Figure 6-2 Basic settings (small apartment)

**Local Device Config**

Device Type  ▼



Device Name

VTO ID



Group Call

Management Center

Table 6-1 Basic parameter description

Parameter	Description
Device Type	<p>Select from <b>Villa Station</b> and <b>Small Apartment</b>.</p> <p></p> <p>The small apartment is available on select models.</p>
Device Name	When other devices are monitoring this VTO, the device name will appear on the monitoring image.
Villa Room No.	VTH room number. Used to call VTHs.
VTO ID	<p>Used to differentiate each VTO, and we recommend you set it according to unit or building number, and then you can add VTOs to the SIP server by using their numbers.</p> <p></p> <p>The number cannot be changed when the VTO serves as the SIP server.</p>
Group Call	Enable it on the VTO that works as the SIP server, and when a main VTH receives a call, all extension VTHs will also receive the call.
Management Center	888888 by default.
Call Period	The time period in which the VTO's calling to other devices is not limited. Click <b>Setting</b> to configure the call period in a day/week.



Parameter	Description
Calling by Period Mode	<ul style="list-style-type: none"> <li>If you enable the <b>Calling by Period Mode</b>, the specified number can be called in the specified period and the default number in other period.</li> <li>Click <b>Setting</b> to set the time plan for calling.</li> </ul>  <p>This function is only available when the mode is villa door station.</p>
Storage Method	SD card by default.
SD Card Usage	Displays the total and used capacity of the SD card. You can click <b>Format SD Card</b> to delete all the data in the SD card.
Auto Capture while Unlocking	<p>Take a snapshot and save it in the SD card of the VTO when the VTO is unlocking.</p>  <p>If the VTO is unlock through local unlock button, the snapshot will not be taken.</p>
Auto Capture during Call	Take a snapshot and save it in the SD card of the VTO when the VTO is calling.
Upload Messages and Videos	<p>When enabled:</p> <ul style="list-style-type: none"> <li>If an SD card is inserted in both the VTH and VTO, the video message will be saved both in the SD cards of the VTH and the VTO.</li> <li>If an SD card is only inserted in the VTH or the VTO, the video message will be saved only in the SD card of the VTH or the VTO.</li> <li>If no SD card is inserted in the VTH or VTO, no video message will be saved.</li> </ul>
Auto Record while Calling	<p>Take recording when the VTO is in a call, and save the recording in the SD card of the VTO.</p>  <ul style="list-style-type: none"> <li>When the call time is less than 5 seconds, no video file will be generated.</li> <li>If there is a conflict between <b>Auto Record while Calling</b> and <b>Leave Videos, Leave Videos</b> prevails.</li> </ul>

Step 3 Click **Apply**.

## 6.1.2 Second Confirmation Station



The configuration of second confirmation station is available on select models.

### Procedure

Step 1 Select **Local Device Config** > **Basic Settings**.

**Step 2** Configure the parameters.

Figure 6-3 Basic settings (Second confirmation station)

Table 6-2 Basic parameter description

Parameter	Description
Device Type	Select <b>Second Confirmation Station</b> .
Device Name	When other devices are monitoring this VTO, the device name will appear on the monitoring image.
Villa Room No.	VTH room number. Used to call VTHs.
VTO ID	Used to differentiate each VTO, and we recommend you set it according to unit or building number, and then you can add VTOs to the SIP server by using their numbers.  The number cannot be changed when the VTO serves as the SIP server.
Management Center	888888 by default.
Management Center Call Period	Configure the time if you only want to receive calls from VTH during a specific period, and then enable the function.
Call Period	Click <b>Setting</b> to configure the call period in a day/week.

**Step 3** Click **Apply**.

## 6.2 Access Control



Different model series have varied access control functions. Here uses the example for configuring the model E series.

### 6.2.1 Configuration

#### Procedure

Step 1 Select **Local Device Config** > **Access Control** > **Config**.

Step 2 Configure the parameters.

Figure 6-4 Access control

Interval between Consecutive...	<input type="text" value="5"/>	s (1-20)
Door Unlocked Duration	<input type="text" value="2"/>	s (1-20)
Alarm Input/Door Detector	<input type="radio"/> Alarm Input <input checked="" type="radio"/> Door Detector	
Check Door Detector Signal ...	<input type="checkbox"/>	
Door Detector Alarm Thresh...	<input type="text" value="30"/>	s (1-9999)
Door Detector Status	<input checked="" type="radio"/> NC <input type="radio"/> NO	
Door Detector Alarm Sound	<input type="checkbox"/>	
Unlock Code	<input type="text" value="123"/>	
<input type="checkbox"/> Lock Linkage		
New Duress Password	<input type="password"/>	
Confirm New Duress Password	<input type="password"/>	
Public Password	<input type="button" value="Setting"/>	
<input type="button" value="Apply"/>	<input type="button" value="Refresh"/>	<input type="button" value="Default"/>

Table 6-3 Access control parameter description

Parameter	Description
Interval between Consecutive Unlocks	The door can only be unlocked again after the interval.
Door Unlocked Duration	The time during which the lock stays unlocked.
Alarm Input/Door Detector	Select one of them.
Check Door Detector Signal Before Locking	Enable the function based on your needs.
Door Detector Alarm Threshold	The threshold time when the door detector alarm is triggered.
Door Detector Status	<ul style="list-style-type: none"> <li>● <b>NC</b> : Normally closed.</li> <li>● <b>NO</b> : Normally open.</li> </ul>
Door Detector Alarm Sound	<p>It is disabled by default.</p> <p>When it is enabled:</p> <ul style="list-style-type: none"> <li>● <b>Door Detector Status</b> is <b>NC</b>: If the door opening time exceeds the set door detection alarm threshold, the VTO will beep. And when the door detector is closed, the VTO does not beep again.</li> <li>● <b>Door Detector Status</b> is <b>NO</b>: If the door closing time exceeds the set door detection alarm threshold, the VTO will beep. And when the door detector is open, the VTO does not beep again.</li> </ul>
Unlock Code	You can connect a third-party phone, such as a SIP phone, to the VTO, and use the code to open the door remotely.
Lock Linkage	Enable the <b>Lock Linkage</b> , and then select the linkage lock from the dropdown list.
New Duress Password	Configure the duress password. If you enter the password when you are forced, the alarm will be sent to the management center.
Confirm New Duress Password	
Public Password	<p>Click <b>Setting</b> to set the public password.</p> <ol style="list-style-type: none"> <li>1. Click <b>Add</b> to add a public password.</li> <li>2. Enter the user name and password. And then click <b>OK</b>.</li> </ol>  <p>The password must consist of 4–6 digits.</p>

Step 3 Click **Apply**.

## 6.2.2 Extension Function

### 6.2.2.1 RS-485

#### Procedure

Step 1 Select **Local Device Config** > **Access Control** > **Extension Function** > **RS-485**.

**Step 2** Configure the parameters of the lock connected through the RS-485 port.

Figure 6-5 RS-485

Table 6-4 RS-485 description

Parameter	Description
Port Type	<b>Lock</b> by default. Card readers can be connected, which only supports compact flash card.
Interval between Consecutive Unlocks	The door can only be unlocked again after the interval.
Unlock Duration	The time during which the lock stays unlocked.
Unlock Code	You can connect a third-party phone, such as a SIP phone, to the VTO, and use the command to open the door remotely. The default command is 456.
Lock Linkage	Enable the <b>Lock Linkage</b> , and then select the linkage lock from the dropdown list.

**Step 3** Click **Apply**.



- When the 485 module of VTO linked with security module (DEE1010B) connects to card reader, the security module has a limit on the length of the entered password (10 digits supported). Therefore, room number (6 digits) + personal password (6 digits) can not unlock the door.

- When the 485 module of VTO linked with security module (DEE1010B) connects to QR card reader, QR code can not unlock the door because the RS-485 of VTO does not support QR code transmission.
- When the 485 module of VTO linked with security module (DEE1010B) connects to card reader, cards cannot be issued through the 485 module and security module DEE1010B, because the 485 module does not support bidirectional command interaction.

### 6.2.2.2 Network Lift Control

The lock can be connected to network lift control.



This function is available only when **Device Type** is selected as **Small Apartment**.

#### Procedure

- Step 1** Select **Local Device Config > Access Control > Extension Function > Network Lift Control**.
- Step 2** Enable the network lift control.
- Step 3** Configure the lift control.

Figure 6-6 Network lift control

Table 6-5 Network lift control description

Parameter	Description
Lift Control Mode	<ul style="list-style-type: none"> <li>● With Lift Controller: Up to 8 lifts can be added.</li> <li>● Without Lift Controller: Up to 6 lifts can be added.</li> </ul>
Verification Method	<p>It is enabled when the <b>Lift Control Mode</b> is set as <b>With Lift Controller</b>.</p> <ul style="list-style-type: none"> <li>● Remote Verification: The verification is made remotely.</li> <li>● Local Verification: The verification is made locally.</li> </ul>
VTO Floor	Each lift controls up to 128 floors.

- Step 4** Click **Edit** to edit the lift information. And then click **OK**.

Figure 6-7 Set lift information

Table 6-6 Network lift control description

Parameter	Description
Lift Control Duration	Set the lift control duration from 0–999 seconds.
IP Address	Set the device IP address, port, user name and password.
Port	
Username	
Password	

Step 5 Click **Apply**.

## Related Operations

Click **Test** to test the connection status of lifts.

## 6.3 Light Control

Configure the illuminator as needed.

### Procedure

Step 1 Select **Local Device Config** > **Light Control**.

Step 2 Set illuminator and device light modes from the following modes.

- **NO** : The illuminator is open all the time.
- **NC** : The illuminator is closed all the time.
- **Self-adaptive** : The illuminator will adapt to the environment, and then sets a suitable value.

- **Period** : The illuminator will be open during the defining period.



Turning off the illuminator will affect motion detection in dark environments.

Step 3 Click **Apply**.

## 6.4 Card Settings

### Procedure

Step 1 Log in to the webpage.

Step 2 Select **Local Device Config** > **Card Settings**.

Figure 6-8 Card settings

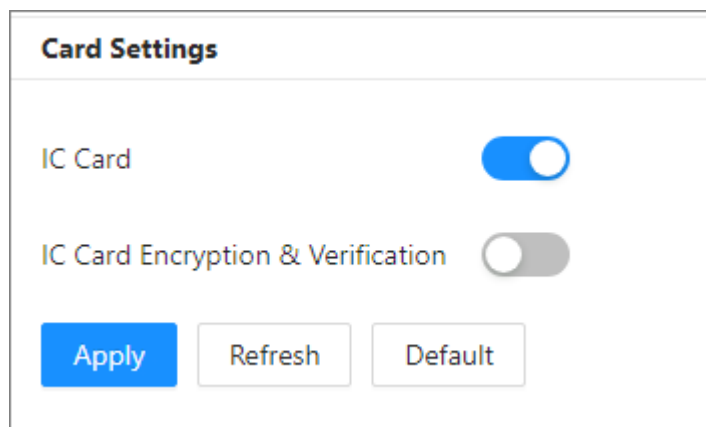

Table 6-7 Description of card parameters

Parameter	Description
IC Card	When enabled, IC card can be used to open the door.
IC Card Encryption & Verification	When enabled, the IC card is encrypted. Swipe the right card with successful encryption detection to open the door.



External card readers do not support encrypted IC cards.

Step 3 Click **Apply**.

## 6.5 Wiegand Settings

Supports access Wiegand devices. Configure the mode and the transmission mode according to your actual devices.

### Procedure

Step 1 Log in to the webpage.

Step 2 Select **Local Device Config** > **Wiegand Settings**.

Step 3 Configure the Wiegand parameters.



Figure 6-9 Wiegand input

Wiegand Settings  Wiegand Input  Wiegand Output

Card No. Inversion

Input Door Channel Local Lock

Apply Refresh Default

Figure 6-10 Wiegand output

Wiegand Settings  Wiegand Input  Wiegand Output

Wiegand Output Type Wiegand 34

Pulse Width (μs) 200 (20-200)

Pulse Interval (μs) 1000 (200-5000)

The pulse width is a multiple of 10 and has a multiple relationship with the pulse interval.

Output Data Type  Card Number  No.

Output Format Hexadecimal

Apply Refresh Default

Table 6-8 Description of Wiegand parameters

Parameter		Description
Wiegand Settings		<ul style="list-style-type: none"> <li>Select <b>Wiegand Input</b> when other recognition devices are connected.</li> <li>Select <b>Wiegand Output</b> when the VTO works as the recognition device. You can connect the access controller or other devices to the VTO.</li> </ul>
Wiegand Input	Card No. Inversion	When the third party devices are connected, if the card number order recognized by the device is different from the actual card number, enable this function to correct it.

Parameter		Description
	Input Door Channel	Select the channel from <b>Local Lock</b> and <b>External Lock</b> .
Wiegand Output	Wiegand Output Type	Select a Wiegand format to read card numbers or ID numbers. <ul style="list-style-type: none"> <li>● <b>Wiegand26</b> : Reads three bytes or six digits.</li> <li>● <b>Wiegand34</b> : Reads four bytes or eight digits.</li> <li>● <b>Wiegand66</b> : Reads eight bytes or sixteen digits.</li> </ul>
	Pulse Width	Enter the pulse width and pulse interval of Wiegand output.
	Pulse Interval	
	Output Data Type	Select the type of output data. <ul style="list-style-type: none"> <li>● <b>Card Number</b> : Outputs data based on user's first card number.</li> <li>● <b>No.</b> : Outputs data based on user ID.</li> </ul>
Output Format	When the output data type is configured as number, select from <b>Decimal</b> and <b>Hexadecimal</b> .	

Step 4 Click **Apply**.

## 6.6 Layout

### 6.6.1 Layout (Multiple Buttons)

This function is only available for select models with multiple buttons (1 button, 2 buttons and 4 buttons). Here is an example of configuration for the VTO that has one button installed on its device.

#### Procedure

- Step 1 Log in to the webpage of the VTO.
- Step 2 Select **Local Device Config** > **Layout**.
- Step 3 Click the nameplates next to where you have installed the button(s), and then select the room number(s) from the **Room No.** you want to bind. For example, 9901, 9902, 9903 and 9904.



- You need to first configure the room number. Otherwise, you have no room number to select from in the module list. VTH room numbers is configured in **Device Setting**. For details, see "7.2 VTH Management".
- You need to configure the room number based on your installation position of buttons. For example, if you have only installed one button next to the first nameplate, then you need to click the module of first nameplate to configure the room number on the webpage. If you have installed one button next to the fourth nameplate, then you need to click the module of fourth nameplate to configure the room number on

the webpage. Keep the above configuration rule when you install 2 buttons or 4 buttons on the VTO and configure the corresponding room numbers on the webpage.

Figure 6-11 Fourth button installation

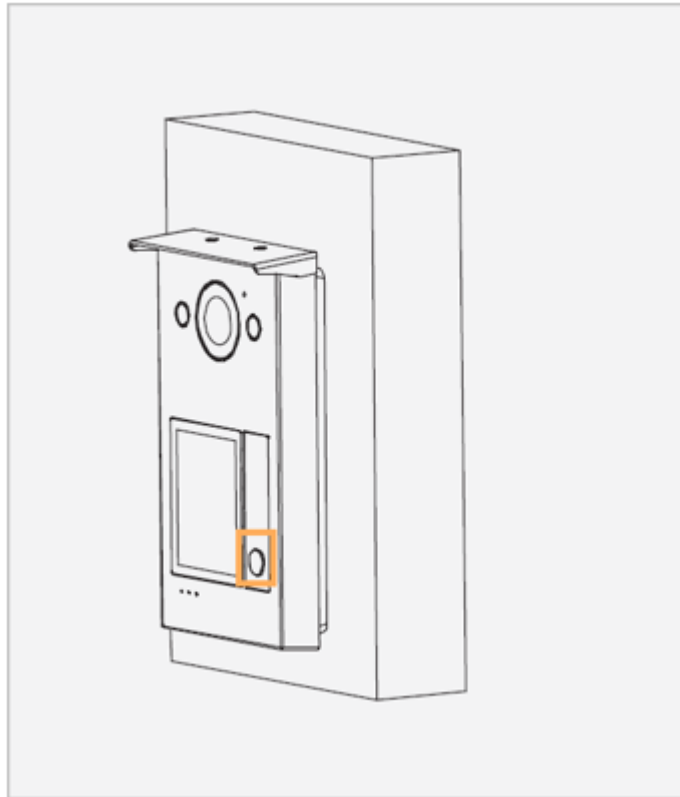

Figure 6-12 Configure the fourth nameplate for room number (1)

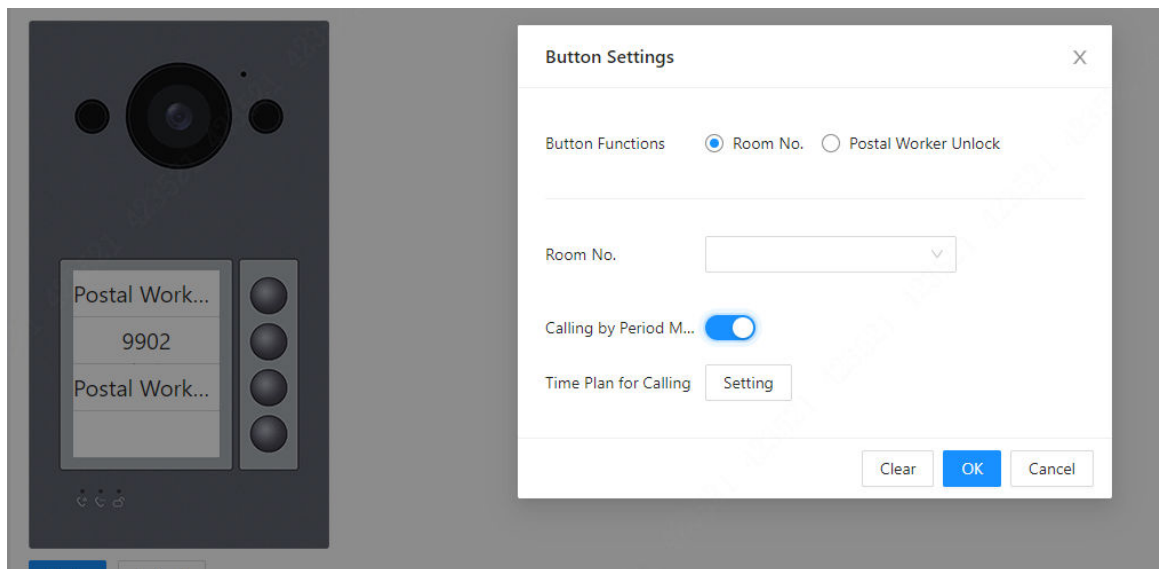
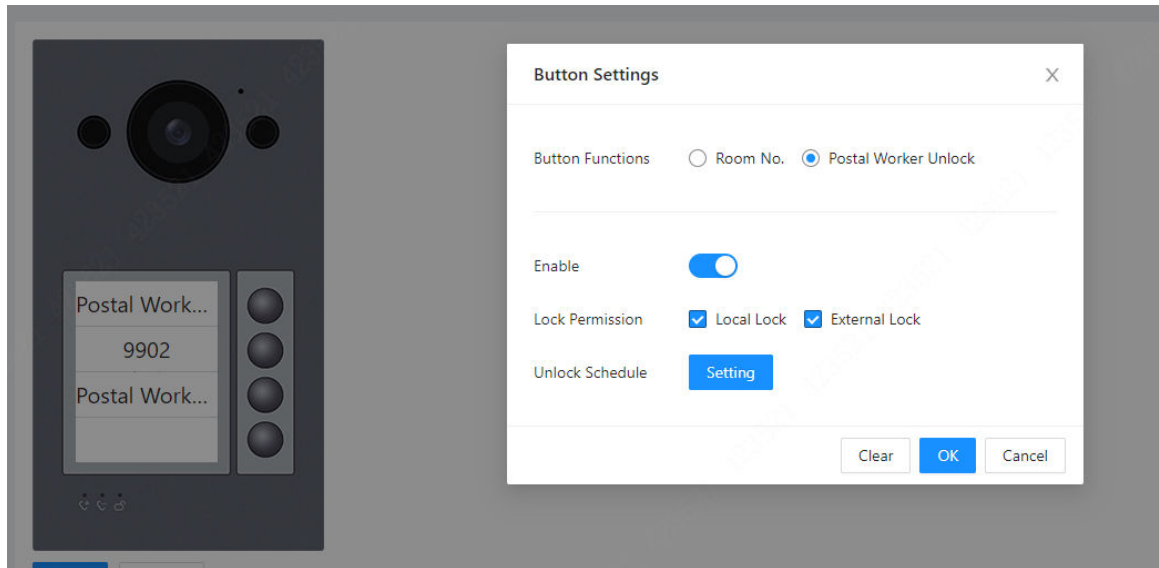

Figure 6-13 Configure the fourth nameplate for postal worker unlock (2)



**Step 4** Click **Apply** to save the selected room number.

**Step 5** If you want to bind room numbers when you install 2 buttons or 4 buttons for the VTO, repeat Step 3 to Step 4 until you have configured all of the room numbers.

## 6.6.2 Layout (Multiple Modules)

This function is only available for select models with multiple modules.

### Procedure

**Step 1** Log in to the webpage of the VTO.

**Step 2** Select **Local Device Config > Layout**.

**Step 3** Click **+** to add modules.

**Step 4** Click the button on the corresponding module to configure the related parameters.



You need to first configure the room number. Otherwise, you have no room number to select from in the module list. VTH room numbers are configured in **Device Setting**. For details, see "7.2 VTH Management".

Figure 6-14 Configure the layout

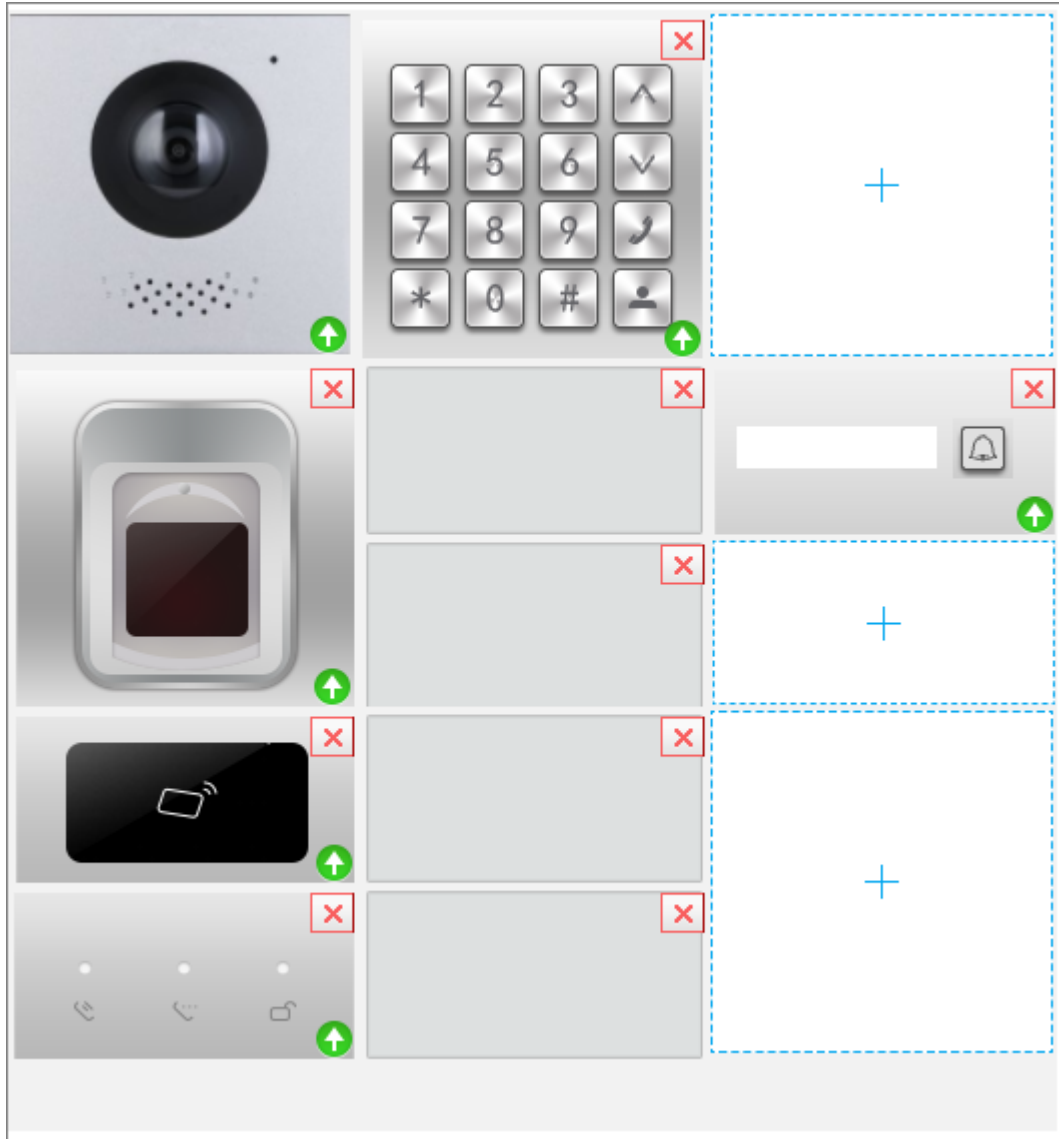

Figure 6-15 Configure the room number

**Button Settings** [X]

Button Functions  Room No.  Postal Worker Unlock

---

Room No.

[Clear] [OK] [Cancel]

Figure 6-16 Configure the postal worker unlock

**Button Settings** [X]

Button Functions  Room No.  Postal Worker Unlock

---

Enable

Lock Permission  Local Lock  External Lock

Unlock Schedule

[Clear] [OK] [Cancel]

Table 6-9 Button parameters description

Parameter	Description
Room No.	Select the room number from the drop-down list.

Parameter	Description
Postal Worker Unlock	Configure the postal worker unlock. <ol style="list-style-type: none"> <li>1. Click <input type="checkbox"/> to enable the function.</li> <li>2. Set the lock permission from <b>Local Lock</b> and <b>External Lock</b>.</li> <li>3. Click <b>Setting</b> to configure the unlock schedule.</li> <li>4. Click <b>OK</b>.</li> </ol>

**Step 5** If you want to bind room numbers when you install other modules with nameplates for the VTO, repeat Step 3 to Step 4 until you have configured all of the room numbers.



When the two-button module, four-button module, and ten-button module are set to single-column button mode, the room number on the left button cannot be edited.

Figure 6-17 Non-editable buttons

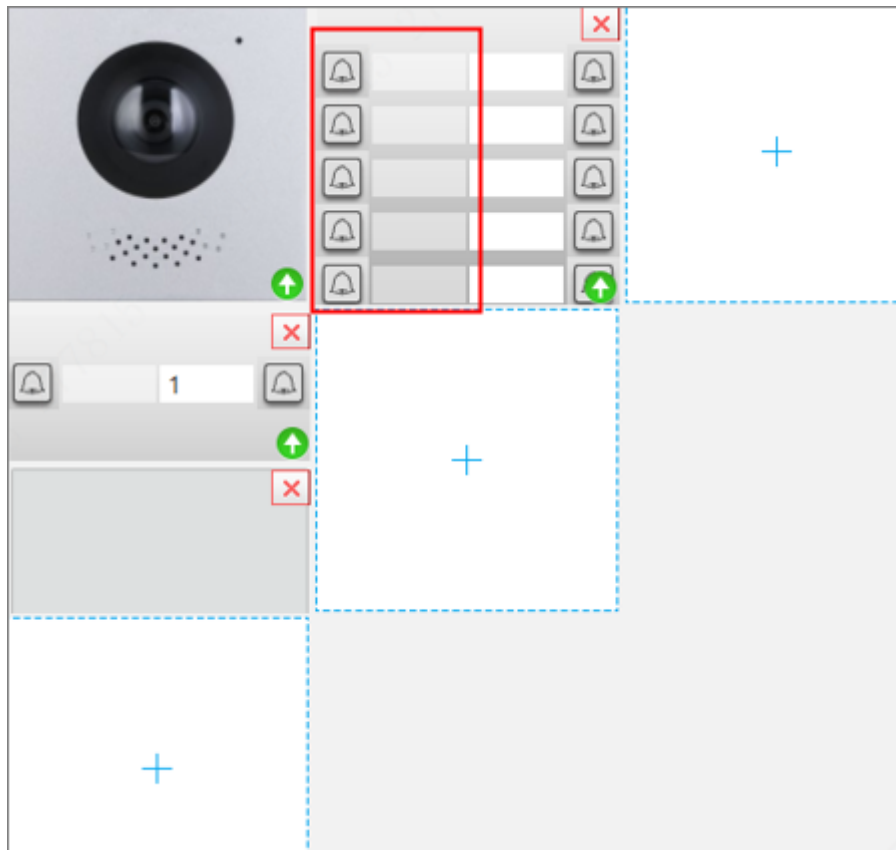

## Related Operations

Click  to view the current version of the module or upload the update file to update the module.

## 6.7 Adding IPC

This function is available only when the SIP server is enabled and the device mode is set to small apartment.

You can add the IPC devices on the webpage of the VTO. The VTHs with the same online SIP server get the IPC information.



- Supports adding the device with up to 32 channels.
- Supports directly adding IPC devices. You can get the IPC channel by adding NVR/XVR/HCVR.

## 6.7.1 Adding IPC One by One

Add the information of the video monitoring device one by one.



Only when the **Device Type** is set as **Small Apartment** and **Fence Station**, and the SIP function is enabled, this function can be available.

### Procedure

**Step 1** Log in to the webpage.

**Step 2** Select **Local Device Config** > **IPC Info**.

Figure 6-18 IPC information

No.	Name	IP Address	Protocol Type	Stream Type	Port	Channel No.	Device Type	Operation
1			Local	Sub Stream	554	0	IPC	
2			Local	Sub Stream	554	0	IPC	
3			Local	Sub Stream	554	0	IPC	
4			Local	Sub Stream	554	0	IPC	
5			Local	Sub Stream	554	0	IPC	
6			Local	Sub Stream	554	0	IPC	
7			Local	Sub Stream	554	0	IPC	
8			Local	Sub Stream	554	0	IPC	

**Step 3** Click to configure the parameters.



Figure 6-19 Configure the parameters

**Edit**
✕

---

Name

IP Address

Protocol Type  ▾

Stream Type  ▾

Device Type  ▾

Channel No.

Encryption

Username

\* Password

Port

Table 6-10 Parameters description of the video monitoring device

Parameter	Description
Name	Enter the name of the IPC/VNR/XVR/HCVR device.
IP Address	Enter the IP address of the IPC/VNR/XVR/HCVR device.
Protocol Type	Select from <b>Local</b> and <b>ONVIF</b> according to the device you add.
Stream Type	Select from <b>Main Stream</b> and <b>Sub Stream</b> .
Device Type	Select the type according to the actual devices.
Channel No.	<ul style="list-style-type: none"> <li>● If you add the IPC, it is 1 by default.</li> <li>● If you add the NVR/XVR/HCVR, it is the channel of IPC that was configured on the VNR/XVR/HCVR device.</li> </ul>

Parameter	Description
Encryption	Keep consistent with the encryption status of the terminal device.
Username	Enter the username and the password that used to log in to the webpage of the IPC/VNR/XVR/HCVR device.
Password	
Port	The value is 554 by default.

Step 4 Click **OK**.

## 6.7.2 Exporting IPC Information in Batches

Export the IPC information and save the information to the local computer.

### Procedure

Step 1 Click **Export**.

Step 2 Enter the login password, and then click **OK**.

The IPC configuration file is saved to the local computer.

## 6.7.3 Importing IPC Information in Batches

Import the IPC information to the system.

### Procedure

Step 1 Click **Import**, and then enter the login password.

Figure 6-20 Import

Step 2 Select the file, and then click **Import**.

# 7 Device Setting

This chapter introduces how to add, modify, and delete VTO, VTH, VTS, and IPC, and how to send messages from the SIP server to VTOs and VTHs when the VTO works as the SIP server. If you are using other servers as the SIP server, see the corresponding manual for details.

## 7.1 VTO Management

You can add VTOs to the SIP server, and all the VTOs connected to the same SIP server can call each other.

### Procedure

- Step 1 Log in to the webpage of the VTO that works as the SIP server.
- Step 2 Select **Device Setting**.
- Step 3 Click **Add**.
- Step 4 Configure the parameters.

Figure 7-1 Add VTO

The screenshot shows a web-based configuration window titled "Add" with a close button (X) in the top right corner. The window contains the following fields and controls:

- Device Type:** A dropdown menu currently set to "VTO".
- \* No.:** A text input field containing the number "8001".
- \* Registration Password:** A password input field containing "\*\*\*\*\*".
- Building No.:** A disabled (greyed out) text input field.
- Unit No.:** A disabled (greyed out) text input field.
- \* IP Address:** An IP address input field containing "127 . 0 . 0 . 1".
- \* Username:** A text input field containing "admin".
- \* Password:** A password input field containing "\*\*\*\*\*".

At the bottom right of the dialog, there are two buttons: "OK" (highlighted in blue) and "Cancel".



Table 7-1 Add VTO configuration

Parameter	Description
Device Type	Select <b>VTO</b> .
No.	The VTO number you configured.
Registration Password	Leave it as default.

Parameter	Description
Building No.	Available only when the platform servers or VTS work as the SIP server.
Unit No.	
IP Address	IP address of the VTO.
Username	Username and password used to log in to the webpage of the VTO.
Password	

Step 5 Click **OK**.



Click  to edit the VTO, or  to delete added VTOs, but the one that you have logged in to cannot be modified or deleted.

## 7.2 VTH Management

You can add room numbers to the SIP server, and then configure the room number on the VTHs to connect them to the network.

### Procedure

- Step 1 Log in to the webpage of the SIP server.
- Step 2 Select **Device Setting**.
- Step 3 Click **Add**.
- Step 4 Configure the parameters.
  - Select the device type as **VTH**.

Figure 7-2 Add VTH one by one

Table 7-2 Parameters description

Parameter	Description
First Name	Enter the information you need to differentiate each room.
Last Name	
Alias	
Room No.	Enter a room number, and then configure the number on a VTH to connect it to the network.
Registration Mode	Select <b>Public</b> .
Registration Password	Leave it as default.
Floor	Select the floor which can be given the permission.  This parameter is available only when <b>Lift Control Mode</b> is selected as <b>With Lift Controller</b> .

- Select the add mode as **Add in Batches**.



**Add in Batches** is not available when the device mode is set to villa.



Figure 7-3 Add VTH in batches

Table 7-3 Parameters description

Parameter	Description
Floors in Unit	Configure the numbers of floors and rooms.
Rooms on Each Floor	
First Room No. on 1st Floor	Configure the first room number on the first and second floor, the room number will be automatically generated.
First Room No. on 2nd Floor	

**Step 5** Click **OK**.



Click  to edit the VTH, or  to delete added VTHs, but the one that you have logged in to cannot be modified or deleted.

## 7.3 VTS Management

You can add a VTS to the SIP server, and then it can be used as the management center. It can also manage, call, or receive calls from all the VTOs and VTHs in the network. See the corresponding user's manual for details.

### Procedure

- Step 1** Log in to the webpage of the VTO that works as the SIP server.
- Step 2** Select **Device Setting**.
- Step 3** Click **Add**.
- Step 4** Configure the parameters.

Figure 7-4 Add VTS

The screenshot shows a dialog box titled "Add" with a close button "X" in the top right corner. The dialog contains the following fields:

- Device Type:** A dropdown menu with "VTS" selected.
- \* VTS No.:** A text input field with the placeholder text "Please enter".
- \* IP Address:** A dotted input field for entering an IP address.
- \* Registration Password:** A text input field with six dots and a copy icon.

At the bottom right of the dialog are two buttons: "OK" (highlighted in blue) and "Cancel".

Table 7-4 Add VTS configuration

Parameter	Description
Device Type	Select <b>VTS</b> .
VTS No.	The number of the VTS.
Registration Password	Leave it as default.
IP Address	VTS IP address.

Step 5 Click **OK**.

# 8 Person Management



The card and fingerprint information that registered on the VTO will be uploaded to the person management in real time.

## Procedure

**Step 1** Log in to the webpage.

**Step 2** Select **Person Management**.

Figure 8-1 Person management

Add Import Person Export Person Delete Clear Refresh							Person ID/Room No./Username	Q
<input type="checkbox"/>	No.	Person ID	Room No.	Username	Verification Mode	Operation		
<input type="checkbox"/>	1	1	1	rh81f0c3n3d9xwi2a	3			
<input type="checkbox"/>	2	2	2	e3tb2gy8q7qjm1d6	1			
<input type="checkbox"/>	3	10000001	300	b4zgy57eomk6rh81f0c3n3d9xwi2a	2			
<input type="checkbox"/>	4	10000002	301	z5ehofvwxnll0n4e3tb2gy8q7qjm1d6	2			
<input type="checkbox"/>	5	10000003	302	ka4jugbqro215lpxzfyhc6wt7dvm38s	2			
<input type="checkbox"/>	6	10000004	303	l5k18r6dbwgtm7yfe92apcuvon34sz	2			
<input type="checkbox"/>	7	10000005	304	ukr2fh5iz4bsm8eaq60w3x1v7ycon	2			
<input type="checkbox"/>	8	10000006	305	l6odx0vc2wb1hiy3apf57zfm94gq	2			
<input type="checkbox"/>	9	10000007	306	teu7r6amdphkwsx12fz5yc8v0q4njz	2			
<input type="checkbox"/>	10	10000008	307	0n5ytkaf9qzo0ecwvd1hujmi62uljgb3	2			

5000 records

< 1 2 3 4 5 ... 500 > 10 / page Go to Page

**Step 3** Click **Add**.

**Step 4** Configure the parameters, and then click **OK**.



Figure 8-2 Add the person

**Add**
✕

---

\* Person ID

\* Room No.

Username

\* Validity Period

\* Lock Permission  Local Lock  External Lock









Multi-Door Unlock ⓘ

**Verification Mode**

> Password	Not Added
> Card	Not Added

Table 8-1 Person parameters description

Parameter	Description
Person ID	Customize the number.
Room No.	Enter the corresponding room number of the VTH.
Username	Enter the user name.
Validity Period	Configure the validity period during which people have access permissions.
Lock Permission	Set the lock permission. You can enable the permission for local lock and external lock at the same time.
Multi-Door Unlock	<p>When verification is successful, the local lock and external lock will open at the same time.</p> <p> Personal password does not support this function.</p>
Password	<ol style="list-style-type: none"> <li>1. Select <b>Password</b> &gt; <b>Add</b>.</li> <li>2. Enter the password, and then confirm it again.</li> </ol> <p> The password must consist of 4-6 digits.</p> <ol style="list-style-type: none"> <li>3. Click <b>OK</b>.</li> </ol>

Parameter	Description
Card	<ol style="list-style-type: none"> <li>1. Select <b>Card &gt; Add</b>.</li> <li>2. Enter the card number. Or you can click <b>Issue Card</b>, and then swipe the card on VTO.</li> <li>3. Click <b>OK</b>.</li> </ol> <p>You can manage the cards through the following icons.</p> <ul style="list-style-type: none"> <li>●  /  : Configure the card as the main card or general card.</li> <li>●  : If you lost your card, click to report the loss. The icon becomes .</li> <li>●  : The card cannot be used to open the door. Click it to make the card valid.</li> <li>●  : Edit the card name.</li> <li>●  : Delete the card.</li> </ul>
Fingerprint	<p>If a kind of modular device is added on <b>Local Device Config &gt; Layout</b>, fingerprint is supported.</p> <ol style="list-style-type: none"> <li>1. Select <b>Fingerprint &gt; Add</b>.</li> <li>2. Record your fingerprint according to the prompts.</li> <li>3. Click <b>OK</b>.</li> </ol>
Floor	<p>Select the floor which can be given the permission.</p>  <p>This parameter is available only when <b>Lift Control Mode</b> is selected as <b>Without Lift Controller</b>.</p>

## Related Operations

- Click **Export Person**, and then enter the encryption password for the file to export the person information.
- Click **Import Person**, and then select the file to import the person information.

# 9 Network Settings

This chapter introduces how to configure the network parameters.

## 9.1 TCP/IP

You need to configure the TCP/IP information to connect the VTO to the network.

### Procedure

- Step 1 Log in to the webpage of the VTO.
- Step 2 Select **Network Settings** > **TCP/IP**.
- Step 3 Configure the TCP/IP parameters.

Figure 9-1 TCP/IP

The screenshot displays the TCP/IP configuration page. At the top, the 'DHCP' toggle switch is turned off. Below this, there are several input fields: 'MAC Address', 'IP Address', 'Subnet Mask', and 'Default Gateway', each with a blurred placeholder. The 'Preferred DNS' field contains '8 . 8 . 8 . 8' and the 'Alternate DNS' field contains '8 . 8 . 4 . 4'. At the bottom, the 'Transmission Mode' section has 'Multicast' selected with a radio button and 'Unicast' unselected. Three buttons are located at the very bottom: 'Apply' (highlighted in blue), 'Refresh', and 'Default'.

Table 9-1 Parameter description

Parameter	Description
DHCP	Automatically assigns IP addresses and other network configuration parameters.
IP Address	Your planned IP address for the VTO.

Parameter	Description
Preferred DNS	It is 8.8.8.8 by default.
Alternate DNS	It is 8.8.4.4 by default.
Transmission Mode	<ul style="list-style-type: none"> <li>• Multicast: Ideal for video talk.</li> <li>• Unicast: Ideal for group call.</li> </ul>  <p>Unicast is not recommended when the platform is being used as an SIP server.</p>

Step 4 Click **Apply**.

## 9.2 Port

### Procedure

Step 1 Select **Network Settings** > **Port**.

Step 2 Configure the parameters.

Figure 9-2 Port

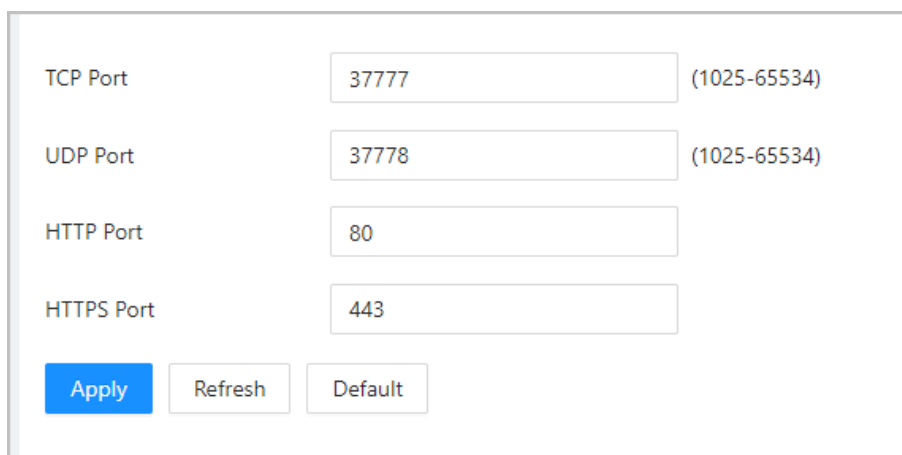

The screenshot shows a configuration form with the following fields and values:

- TCP Port: 3777 (range 1025-65534)
- UDP Port: 3778 (range 1025-65534)
- HTTP Port: 80
- HTTPS Port: 443

At the bottom, there are three buttons: **Apply** (highlighted in blue), **Refresh**, and **Default**.

Table 9-2 Parameter description

Parameter	Description
HTTP Port	You can now enter http://VTO IP address: HTTP Port to log in to the VTO.
TCP/UDP Port	Used for accessing the VTO with devices in other networks.
HTTPS Port	You can now enter https://VTO IP address: HTTPS Port to log in to the VTO.

Step 3 Click **Apply**.

## 9.3 SIP Server

There must be a SIP server in the network for all connected VTOs and VTHs to call each other. You can use a VTO or other servers as the SIP server.

### Procedure

Step 1 Select **Network Settings** > **SIP Server**.

Step 2 Select a server type.

- The VTO you have logged in as the SIP server: Enable **Local SIP Server**, and then configure the parameters for the VTO.



Some parameters would become grey after enabling the **Local SIP Server** function.

Figure 9-3 Current VTO as SIP server

Local SIP Server	<input checked="" type="checkbox"/>
Port	5060
SIP No.	8001
Registration Password	.....
SIP Domain	VDP
Cascade SIP Server	<input type="checkbox"/>
Backup SIP Server	<input type="checkbox"/>
<input type="button" value="Apply"/> <input type="button" value="Refresh"/> <input type="button" value="Default"/>	

- If another VTO works as the SIP server: Select the SIP type as **Device**, and then configure the parameters for the VTO working as the SIP.



If the VTO you have logged in does not work as the SIP server, do not enable **Local SIP Server**. Otherwise, the connection would fail.

Figure 9-4 Another VTO as SIP server

Table 9-3 SIP server configuration (VTO as the SIP server)

Parameter	Description
Server Address	Planned IP address of the VTO.
Port	5060 by default.
SIP No.	VDP by default. Leave it as default.
Registration Password	
SIP Domain	
SIP Server Username	Username and password used to log into the webpage of the SIP server.
SIP Server Password	

- The DSS platform works as the SIP server: Set **Private SIP Server** as **Server Type**, and then configure the parameters.

Figure 9-5 Private SIP server

Table 9-4 SIP server description (platform as the SIP server)

Parameter	Description
Server Address	IP address of the SIP server.
Port	5080 by default when the platform works as the SIP server.
SIP No.	Leave it by default.
Registration Password	
SIP Domain	
Device as Alternate Server	Enable it so that you can configure the Alternate VTS IP.
Alternate IP	<p>The alternate server will be used as the SIP server when Express or DSS stops responding. We recommend you configure the alternate IP address.</p> <p></p> <ul style="list-style-type: none"> <li>◇ If you enable <b>Device as Alternate Server</b>, the current VTO you have logged in serves as the alternate server.</li> <li>◇ If you want another VTO serve as the alternate server, you need to enter the IP address of that VTO in the <b>Alternate IP</b> textbox. Do not enable <b>Device as Alternate Server</b> in this case.</li> </ul>
Alternate Server Username/ Password	Used to log in to the alternate server.
Alternate VTS IP	IP address of the alternate VTS.

**Step 3** Click **Apply**.



- For some third-party servers, if the intercom selects two unlocking methods of the **RFC 2833** and **SIP INFO** at the same time, the unlocking code will not available to unlock the intercom.
- When a third-party server is used to support a third-party intercom, the intercom exception or SIP offline may occur on some servers.

- If **Third-party Server-Asterisk** and **SIP Intercom** select two unlocking methods of the **RFC 2833** and **SIP INFO** at the same time, the unlocking code will not available to unlock the intercom.
- If IB intercom frequently disconnects from the 3CX server, the mapping relationship needs to be deleted.

## 9.4 Second Confirmation Station Cascading

It applied to the situation when the second confirmation station cascades to the VTH.

### Prerequisites

The software version of the VTH must be V4.7 and later.

### Procedure

Step 1 Select **Network Settings** > **SIP Server**.

Step 2 Configure the second confirmation station information in **Local Device Config** > **Basic Settings**.



The device type should be set as **Second Confirmation Station**.

Step 3 Set **Server Type** as **Device**, and then configure the parameters.

In this cascading situation, the VTH works as the SIP server.

Figure 9-6 SIP server configuration (VTH as the SIP server)

Local SIP Server	<input type="checkbox"/>
Server Type	Device
Server Address	[Blurred]
Port	5060
SIP No.	8001
Registration Password	••••••••••••••••
SIP Domain	VDP
SIP Server Username	admin
SIP Server Password	••••••••••••••••
<input type="button" value="Apply"/> <input type="button" value="Refresh"/> <input type="button" value="Default"/>	



Table 9-5 SIP server configuration description (VTH as the SIP server)

Parameter	Description
Server Address	Your planned IP address of the VTH.
Port	5060 by default.
SIP No.	Leave it as default.
Registration Password	
SIP Domain	
SIP Server Username	Username and password used to log into the VTH that serves as the SIP server.
SIP Server Password	

Step 4 Click **Apply**.

## 9.5 Cloud Service

Enable the **Cloud Service** function, and then you can scan the QR code with your phone to add the VTO to the app on your phone.

Figure 9-7 Cloud service

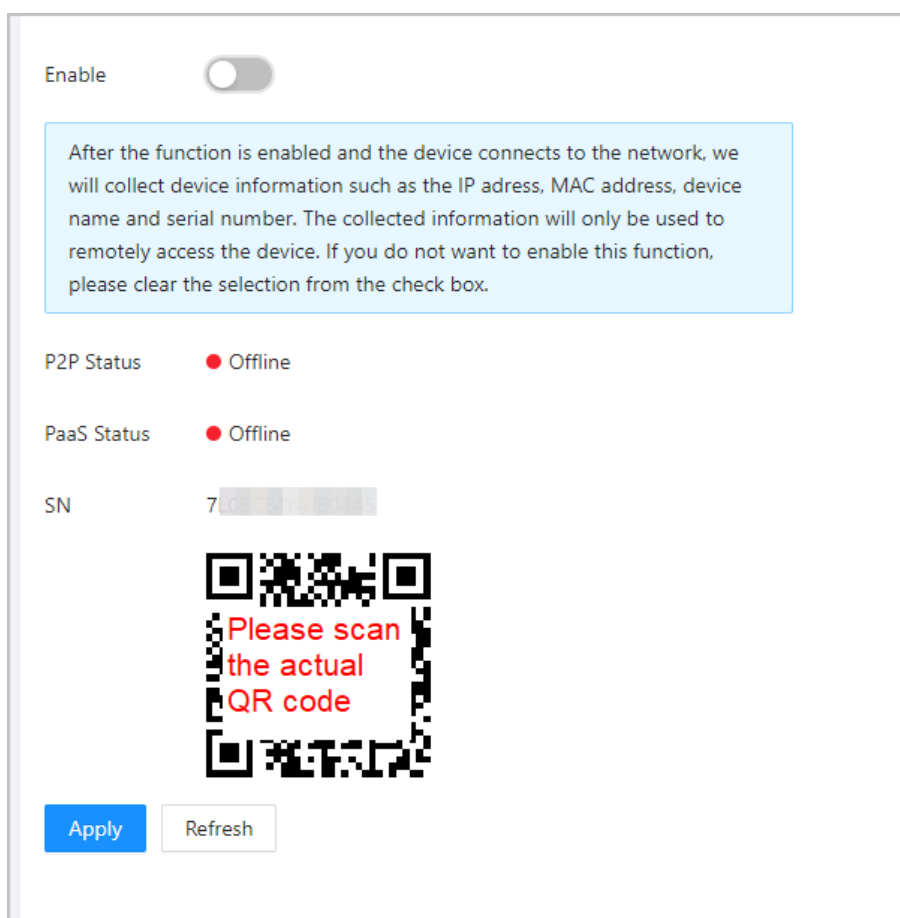

## 9.6 UPnP

When the VTO works as the SIP server, you can configure the UPnP function to allow WAN devices to log in to the VTO.

Figure 9-8 UPnP

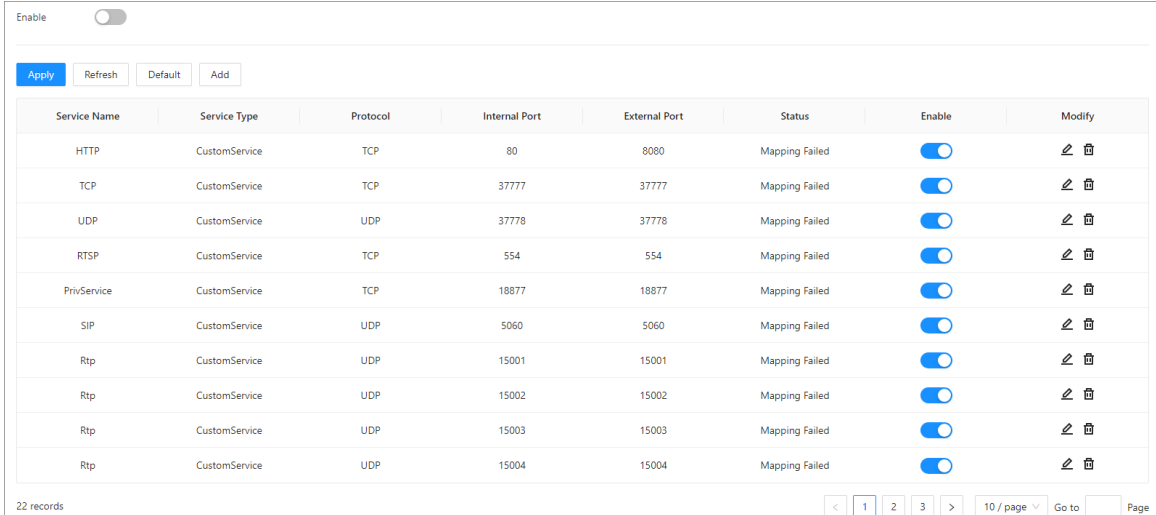

The screenshot shows a web interface for configuring UPnP services. At the top, there is an 'Enable' toggle switch. Below it are buttons for 'Apply', 'Refresh', 'Default', and 'Add'. The main part of the interface is a table with the following columns: Service Name, Service Type, Protocol, Internal Port, External Port, Status, Enable, and Modify. The table contains 10 rows of service entries. At the bottom, there is a pagination bar showing '22 records' and a page number '1'.

Service Name	Service Type	Protocol	Internal Port	External Port	Status	Enable	Modify
HTTP	CustomService	TCP	80	8080	Mapping Failed	<input checked="" type="checkbox"/>	<a href="#">✎</a> <a href="#">🗑</a>
TCP	CustomService	TCP	37777	37777	Mapping Failed	<input checked="" type="checkbox"/>	<a href="#">✎</a> <a href="#">🗑</a>
UDP	CustomService	UDP	37778	37778	Mapping Failed	<input checked="" type="checkbox"/>	<a href="#">✎</a> <a href="#">🗑</a>
RTSP	CustomService	TCP	554	554	Mapping Failed	<input checked="" type="checkbox"/>	<a href="#">✎</a> <a href="#">🗑</a>
PrivService	CustomService	TCP	18877	18877	Mapping Failed	<input checked="" type="checkbox"/>	<a href="#">✎</a> <a href="#">🗑</a>
SIP	CustomService	UDP	5060	5060	Mapping Failed	<input checked="" type="checkbox"/>	<a href="#">✎</a> <a href="#">🗑</a>
Rtp	CustomService	UDP	15001	15001	Mapping Failed	<input checked="" type="checkbox"/>	<a href="#">✎</a> <a href="#">🗑</a>
Rtp	CustomService	UDP	15002	15002	Mapping Failed	<input checked="" type="checkbox"/>	<a href="#">✎</a> <a href="#">🗑</a>
Rtp	CustomService	UDP	15003	15003	Mapping Failed	<input checked="" type="checkbox"/>	<a href="#">✎</a> <a href="#">🗑</a>
Rtp	CustomService	UDP	15004	15004	Mapping Failed	<input checked="" type="checkbox"/>	<a href="#">✎</a> <a href="#">🗑</a>

### Preparation

- Enable the UPnP function on the router, and then configure a WAN IP address for the router.
- Connect the VTO to the LAN port of the router.

### 9.6.1 Enabling UPnP Services

#### Procedure

- Step 1 Select **Network Settings** > **UPnP**.
- Step 2 Select the services listed, and then click **Enable**.
- Step 3 Click **Apply**.



### 9.6.2 Adding UPnP Services

#### Procedure

- Step 1 Select **Network Settings** > **UPnP**.
- Step 2 Click **Add**.
- Step 3 Configure the parameters, and then click **OK**.

Figure 9-9 Add a UPnP service

Table 9-6 Parameter description

Parameter	Description
Service Name	Enter the name and type of the service.
Service Type	
Protocol	Select <b>TCP</b> or <b>UDP</b> .
Internal Port	<p>Internal port of the service.</p>  <ul style="list-style-type: none"> <li>• If you need to configure this function for multiple devices, make sure that the ports are not the same.</li> <li>• The port number you use must not be occupied.</li> <li>• The internal and external port number must be the same.</li> </ul>
External Port	<p>External port of the service.</p>  <ul style="list-style-type: none"> <li>• If you need to configure this function for multiple devices, make sure that the ports are not the same.</li> <li>• The port number you use must not be occupied.</li> <li>• The internal and external port number must be the same.</li> </ul>

## 9.7 Wi-Fi

If the VTO supports Wi-Fi function, then configure the parameters here.

### Procedure

Step 1 Log in to the webpage of the VTO.

Step 2 Select **Network Settings** > **Wi-Fi**.

Step 3 Set the **Wi-Fi** status as **On**.

All the networks available are displayed.

Figure 9-10 Wi-Fi

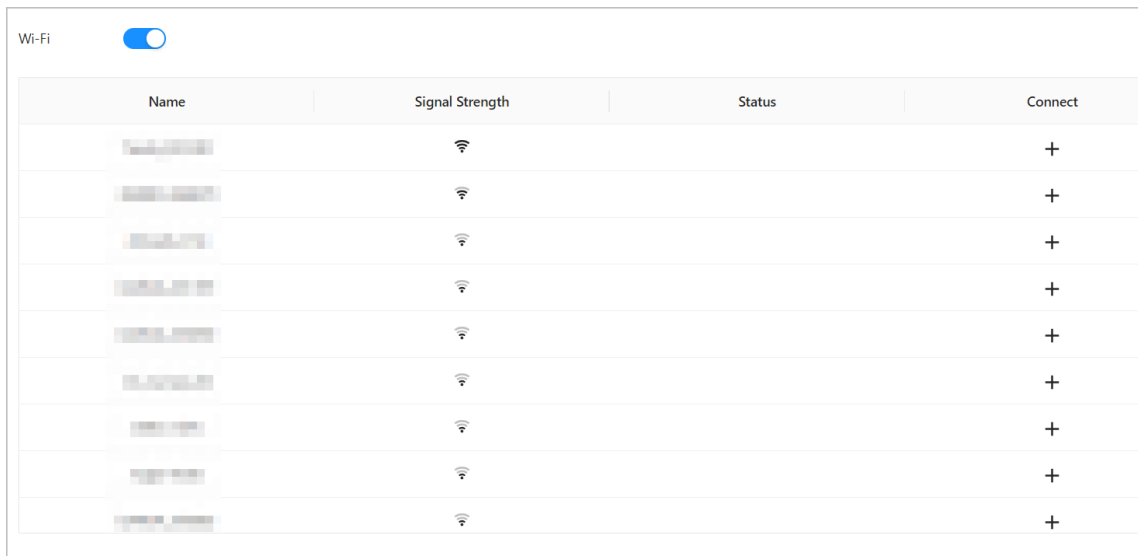

The screenshot shows the Wi-Fi settings interface. At the top, there is a toggle switch for Wi-Fi, which is currently turned on (blue). Below the toggle is a table listing available Wi-Fi networks. The table has four columns: Name, Signal Strength, Status, and Connect. Each row represents a network, with a Wi-Fi signal strength icon in the Signal Strength column and a plus sign (+) in the Connect column.

Name	Signal Strength	Status	Connect
[Blurred]	[Wi-Fi icon]		+
[Blurred]	[Wi-Fi icon]		+
[Blurred]	[Wi-Fi icon]		+
[Blurred]	[Wi-Fi icon]		+
[Blurred]	[Wi-Fi icon]		+
[Blurred]	[Wi-Fi icon]		+
[Blurred]	[Wi-Fi icon]		+
[Blurred]	[Wi-Fi icon]		+
[Blurred]	[Wi-Fi icon]		+
[Blurred]	[Wi-Fi icon]		+

Step 4 Click + of the Wi-Fi you chose, enter the password of it, and then connect to the network.

## 9.8 Basic Services

Configure functions that involve device security.

### Procedure



Step 1 Select **Network Settings** > **Basic Services**.

Step 2 Enable the security functions based on your needs.

Figure 9-11 Basic services

Table 9-7 Security parameter description

Parameter	Description
SSH	A secure alternative to unsecured remote protocols.  We recommend you turn it off because there might be safety risk if this service is enabled.
CGI	The use of CGI command.  We recommend you turn it off. Otherwise, the VTO might be exposed to security risks and data leakage.
Mobile Push Notification	Send information to the app on the phone.  We recommend you turn it off if you do not need this function. Otherwise, the VTO might be exposed to security risks and data leakage.
Password Reset	If turned off, you will not be able to reset password.
Outbound Service Information Protection	Protect your passwords.  We recommend you turn it on. Otherwise, the VTO might be exposed to security risks and data leakage.

Parameter	Description
Multicast/Broadcast Search	<p>Enable it so that the VTO will be found by other devices.</p>  <p>We recommend you turn it off. Otherwise, the VTO might be exposed to security risks and data leakage.</p>
Authentication Mode	<ul style="list-style-type: none"> <li>● <b>Security Mode</b> (recommended): Support logging in with Digest authentication.</li> <li>● <b>Compatibility Mode</b> : Use the old login method.</li> </ul>  <p>We recommend you use the security mode. Compatible mode might expose the VTO to security risks and data leakage.</p>
Emergency Maintenance	<p>For easy access to our after-sales service, enable this function. If the device has any trouble performing functions, such as updating, the system will automatically enable this function.</p>
Password Expires in	<ul style="list-style-type: none"> <li>● Select an expiration period from <b>30 days</b>, <b>60 days</b>, <b>90 days</b>, <b>180 days</b>, <b>Custom</b> and <b>Never</b>.</li> <li>● If you select <b>Custom</b>, you need to configure an expiration day between 0 and 180.</li> </ul>
Private Protocol	<p>Before enabling private protocol TLS, make sure that the corresponding device or software supports this function.</p>
TLSv1.1	 <p>We recommend you turn it off because there might be safety risk if this service is enabled.</p>
LLDP	<p>Improves the efficiency of information exchange among network devices.</p>

Step 3 Click **Apply**.

## 9.9 Auto Registration

VTO automatically registers on the server, and reports its IP address to the designated server.

### Procedure

Step 1 Log in to the webpage of VTO.

Step 2 Select **Network Settings** > **Auto Registration**.

Step 3 Enable the function. Enter the server address, port number and registration ID.

Figure 9-12 Auto registration

Enable

Server Address

Port  (1-65535)

Registration ID

Table 9-8 Parameters description

Parameter	Description
Server Address	IP address or domain name of the server that is needed in registration.
Port	Port number that the server automatically registers.
Registration ID	The server distributes an ID for the device. Keep consistent with the ID registered on the server.

Step 4 Click **Apply**.

# 10 System

## 10.1 Alarm

### Procedure

Step 1 Select **System** > **Alarm**.

Figure 10-1 Alarm

The screenshot shows a configuration page for the Alarm system. It is divided into two main sections: 'Calling Alarm' and 'Tamper Alarm'. Under 'Calling Alarm', there is a single toggle switch labeled 'Calling Alarm' which is currently turned off. Under 'Tamper Alarm', there are three toggle switches: 'Tamper Sound', 'Report Event', and 'Restore Device for M...', all of which are currently turned on. At the bottom of the page, there are three buttons: 'Apply' (highlighted in blue), 'Refresh', and 'Default'.

Step 2 Configure the parameters, which will take effect upon change.

Table 10-1 Alarm parameter description

Parameter	Description
Calling Alarm	When the call is initiated, the alarm output will be linked. If the alarm out interface is connected with a buzzer, it will beep.
Tamper Sound	Configure whether the device whistles locally or not. It is enabled by default.
Report Event	Configure whether the device reports the tamper alarm to the APP, indoor unit, and back-end of the platform or not. It is enabled by default.
Restore Device for Multiple Tamper Alarms	Within 10 minutes after the device is powered on, if you continuously press the tamper button for 5 times in 8 seconds, the device beeps and deletes the account information.



Step 3 Click **Apply**.

## 10.2 Video

Configure the video format and quality, and audio of the VTO.

### Procedure

Step 1 Select **System > Video**.

Figure 10-2 Video

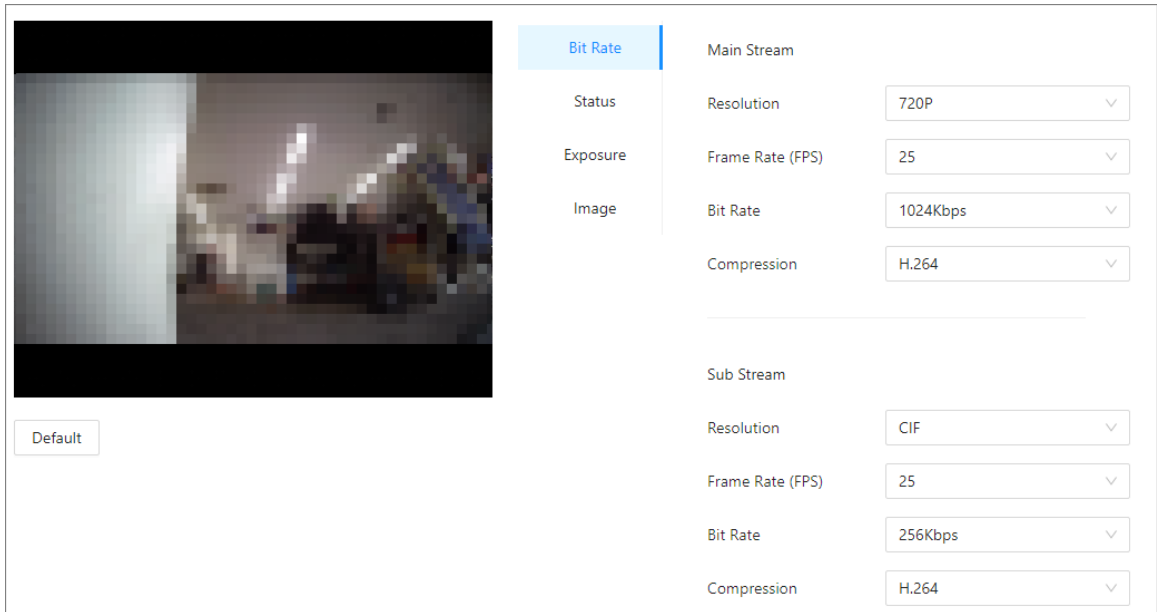

Step 2 Configure the parameters, which will take effect upon change.

Table 10-2 Video parameter description

Parameter		Description	
Bit Rate	Main Stream	Resolution	<ul style="list-style-type: none"> <li>● <b>720P</b> : 1280 × 720.</li> <li>● <b>WVGA</b> : 800 × 480.</li> <li>● <b>D1</b> : 704 × 576.</li> <li>● <b>CIF</b> : 352 × 288.</li> </ul>
		Frame Rate (FPS)	<ul style="list-style-type: none"> <li>● If select the <b>Video Standard</b> as <b>PAL</b>: The range is 1 to 25.</li> <li>● If select the <b>Video Standard</b> as <b>NTSC</b>: The range is 1 to 30).</li> </ul> <p>The larger the value, the smoother the video, but it requires more bandwidth.</p>
		Bit Rate	The larger the value, the better the video quality, but it requires more bandwidth.
		Compression	Compared with H.264, H.265 requires smaller bandwidth.

Parameter		Description	
	Sub Stream	Resolution	<ul style="list-style-type: none"> <li>● <b>1080P</b> : 1920 × 1080.</li> <li>● <b>WVGA</b> : 800 × 480.</li> <li>● <b>QVGA</b> : 320 × 240.</li> <li>● <b>D1</b> : 704 × 576.</li> <li>● <b>CIF</b> : 352 × 288.</li> </ul>
		Frame Rate (FPS)	The range is 1 to 25. The larger the value, the smoother the video, but it requires more bandwidth.
		Bit Rate	Include 224 Kbps, 256 Kbps, 320 Kbps, 384 Kbps, 448 Kbps, 512 Kbps, 640 Kbps, 768 Kbps. The larger the value, the better the video quality, but it requires more bandwidth.
		Compression	H.264. H.265.
Status	Scene Mode		Select from <b>Auto</b> , <b>Disable</b> , <b>Sunny</b> and <b>Night</b> . <b>Auto</b> is selected by default.
	Compensation Mode		<ul style="list-style-type: none"> <li>● <b>BLC</b> : Back light compensation. Improve the clarity of the target in the image.</li> <li>● <b>WDR</b> : Wide dynamic range. Enhance the brightness of dark areas, and reduce the brightness of bright areas to improve the image.</li> <li>● <b>HLC</b> : High light compensation. Reduce the brightness of the strong spots to improve the overall image.</li> <li>● <b>Disable</b>: Do not use any compensation mode.</li> </ul>
	Day/Night		Select from <b>Color</b> , <b>Auto</b> and <b>B/W</b> .
	Video Standard		Select <b>PAL</b> or <b>NTSC</b> according to your area.
	Illuminator Sensitivity		Configure the sensitivity value. <ul style="list-style-type: none"> <li>● If the illumination intensity is lower than the configured value, the illuminator will be turned on.</li> <li>● If the illumination intensity is higher than the configure value, the illuminator will be turned off.</li> </ul>

Parameter		Description
Exposure	Anti-flicker	<ul style="list-style-type: none"> <li>● <b>50Hz</b> : The system adjusts the exposure according to ambient light automatically to ensure that stripes do not appear.</li> <li>● <b>60Hz</b> : The system adjusts the exposure according to ambient light automatically to ensure that stripes do not appear.</li> <li>● <b>Outdoor</b> : If you select <b>Outdoor</b>, the exposure mode can be set to <b>Gain Priority, Shutter Priority</b> and <b>Iris Priority</b>. Different devices support different exposure modes.</li> </ul>
	Exposure Mode	<ul style="list-style-type: none"> <li>● <b>Auto</b> : Exposure is automatically adjusted according to scene brightness if the overall brightness of images is in the normal exposure range.</li> <li>● <b>Manual</b> : You can adjust the <b>Gain</b> and <b>Shutter</b> value manually.</li> <li>● <b>Shutter Priority</b> : The camera automatically adjusts the aperture size based on the selected shutter speed to ensure proper exposure.</li> </ul>
	Exposure Compensation	You can set the exposure compensation value. The value ranges from 0 to 100. The higher the value is, the brighter the image will be.
	3D NR	Reduce the noise of multiple-frame (at least two frames) images by using inter-frame information between two adjacent frames in a video. The higher the level is, the lower the noise will be, and the larger the trailing smear will be.
	NR Level	Noise reduction grade. The value ranges from 0 to 100. The larger the value is, the less the noise will be.
Image	Brightness	The larger the value, the brighter the image.
	Contrast	Larger value for more contrast between bright and dark areas.
	Hue	Make the color brighter or darker. The default value is made by the light sensor, and we recommend keeping it default.
	Saturation	The larger the value, the thicker the color.
	Mirror	Display the image with left and right side reversed.
	Flip	Display the image upside down.
	Display Time	Display the current time and date on the video image.

- Step 3** (Optional) Configure the video clip.  
 Click **Left** or **Right** to swing the screen to the left or right.  
 Click **Reset** or **Default** to reset or default the device.



The function is only available for the mode of F.

## Related Operations

Click **Default** to restore to default configurations.

# 10.3 Audio

## Procedure

- Step 1** Select **System > Audio**.  
**Step 2** Configure the parameters, which will take effect upon change.

Figure 10-3 Audio

Audio Type	Audio File	Modify
Calling	-	⬆️⬆️
Busy	-	⬆️⬆️
Successfully Unlocked	-	⬆️⬆️
Nobody Answered	-	⬆️⬆️
Call Ended	-	⬆️⬆️
Nonexistent Number	-	⬆️⬆️

Table 10-3 Audio parameter description

Parameter	Description
Audio Control	Turn on or off each type of sound.

Parameter		Description
Volume Control	Microphone Volume	Adjust the microphone volume of the VTO. The higher the value is, the higher the volume will be.
	Speaker Volume	Adjust the speaker volume. The higher the value is, the higher the volume will be.
	Device Volume	Adjust the device volume. The higher the value is, the higher the volume will be.

Step 3 Click **Apply**.

Step 4 (Optional) Upload audio file by clicking  next to the corresponding audio type (including calling, busy, successfully unlocked, nobody answered, call ended and nonexistent number).



Please upload a WAV or MP3 file. The file size must not exceed 100K.

## 10.4 Time

Configure the time zone and day light saving parameters.

### Procedure

Step 1 Select **System > Time**.

Step 2 Configure the time and time zone and DST.

Figure 10-4 Time

### Time and Time Zone

Date :  
2023-07-10 Monday

Time :  
13:46:16

Time  Manually Set  NTP

System Time

Time Format

Time Zone

#### DST

Enable





Type  Date  Week

Start Time

End Time

Table 10-4 Parameter description

Module	Parameter	Description
Time and Time Zone	Time	<ul style="list-style-type: none"> <li>Manually Set</li> <li>NTP</li> </ul>
	System Time	<p>The time of the VTO system.</p> <p>Changing system time might cause problems on video searching and information publication. Turn off video recording and auto snapshot before changing it.</p> <p>Only applicable under the <b>Manually Set</b> mode.</p>
	Sync PC	<p>Synchronize the VTO system time with your PC.</p> <p>Only applicable under the <b>Manually Set</b> mode.</p>

Module	Parameter	Description
	Server	The address of the NTP server.  Only applicable under the <b>NTP</b> mode.
	Manual Update	Click the icon and the device time of the VTO will be automatically synchronized with server.  Only applicable under the <b>NTP</b> mode.
	Port	NTP server port number.  Only applicable under the <b>NTP</b> mode.
	Interval	VTO time update cycle. 30 minutes at most.  Only applicable under the <b>NTP</b> mode.
	Time Format	For the date format, select from one of the following: <ul style="list-style-type: none"> <li>● YYYY-MM-DD</li> <li>● MM-DD-YYYY</li> <li>● DD-MM-YYYY</li> </ul> For the time format, select from one of the following: <ul style="list-style-type: none"> <li>● 24-Hour</li> <li>● 12-Hour</li> </ul>
	Time Zone	Select the time zone for the VTO system.
DST	Enable	Click to enable the <b>DST</b> function.
	Type	Select <b>Date</b> or <b>Week</b> as needed, and then configure the specific period.
	Start Time	Configure the start time and end time of DST.
	End Time	

Step 3 Click **Apply**.

## 10.5 ONVIF User

Add accounts for devices to monitor the VTO through the ONVIF protocol.



Only Profile C and Profile S are supported, while the encoding format and image parameters are not supported.

### Procedure

Step 1 Select **System** > **ONVIF User**.

Step 2 Click **Add**.

Step 3 Enter the information, and then click **OK**.

ONVIF devices can monitor the VTO by using the account.

Figure 10-5 ONVIF user

The image shows a software dialog box titled "Add" with a close button (X) in the top right corner. The dialog contains three input fields, each preceded by a red asterisk indicating a required field:

- \* Username:** The input field contains the text "Jack".
- \* Password:** The input field contains seven dots. Below the field is a password strength indicator consisting of a horizontal bar that is approximately 70% filled with orange and 30% with light blue.
- \* Confirm Password:** The input field contains seven dots.

At the bottom right of the dialog, there are two buttons: a blue "OK" button and a white "Cancel" button with a grey border.



# 11 Log Management

Select **Maintenance Center** > **Log**. You can search for different logs, and export them to your local computer.



If storage is full, the oldest records will be overwritten. Back up the records in time.

## 11.1 One-Click Diagnosis

The system automatically diagnoses the configurations and the status of the device to improve its performance.

### Procedure

- Step 1** Log in to the webpage.
- Step 2** Select **Maintenance Center** > **One-click Diagnosis**.
- Step 3** Click **Diagnose**.

The system automatically diagnoses the configurations and the status of the device and display diagnosis results after it completes.

- Step 4** (Optional) Click **Details** to view details of abnormal items.

You can ignore the abnormality or optimize it. You can also click **Diagnose Again** to perform automatic diagnosis again.

Figure 11-1 One-click diagnosis

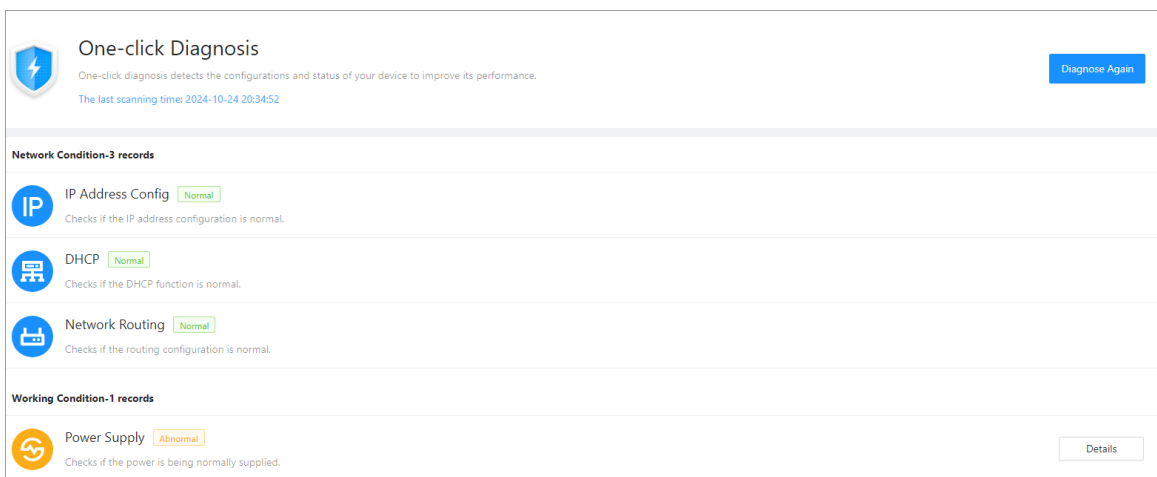

## 11.2 System Information

### 11.2.1 Version Information

#### Procedure

- Step 1** Select **Maintenance Center** > **System Info** > **Version**.
- Step 2** View the software version, SCM version and security baseline version.

Figure 11-2 System information



Device Model	[Redacted]
Device SN	[Redacted]
Hardware Version	[Redacted]
Software Version	[Redacted]
SCM Version	[Redacted]
Web Version	[Redacted]
Security Baseline Version	[Redacted]

## 11.2.2 Legal Information

Select **Maintenance Center** > **System Info** > **Legal Info**. You can view related legal information notices in this section.

## 11.3 Data Capacity

You can see how many users, cards and face images that the VTO can store.

Log in to the webpage and select **Maintenance Center** > **Data Capacity**.

## 11.4 Maintenance Management

### 11.4.1 Config

You can export and import the configuration file.

#### Procedure

- Step 1 Select **Maintenance Center** > **Maintenance Management** > **Config**.
- Step 2 Click **Export Configuration File**, or click **Browse** to select the file from local computer, and then click **Import file**.

Figure 11-3 Config

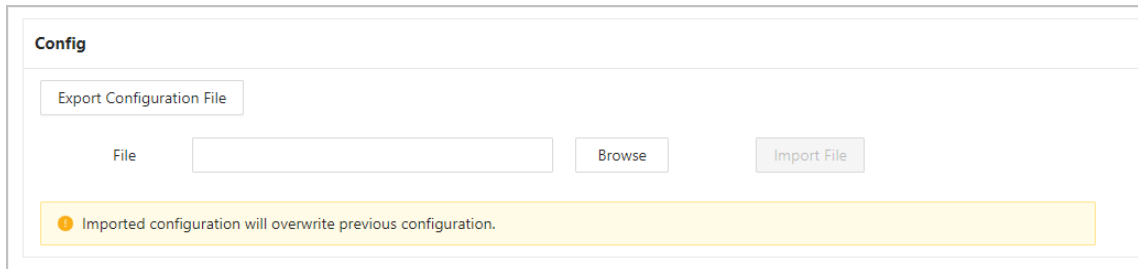

The screenshot shows a web interface titled "Config". At the top, there is a button labeled "Export Configuration File". Below it, there is a "File" input field, a "Browse" button, and an "Import File" button. At the bottom of the interface, there is a yellow warning box with a circular icon containing an exclamation mark, followed by the text: "Imported configuration will overwrite previous configuration."

## 11.4.2 Maintenance

### Procedure

- Step 1 Select **Maintenance Center > Maintenance Management > Maintenance.**
- Step 2 Configure the auto maintenance time.

Figure 11-4 Auto Maintenance

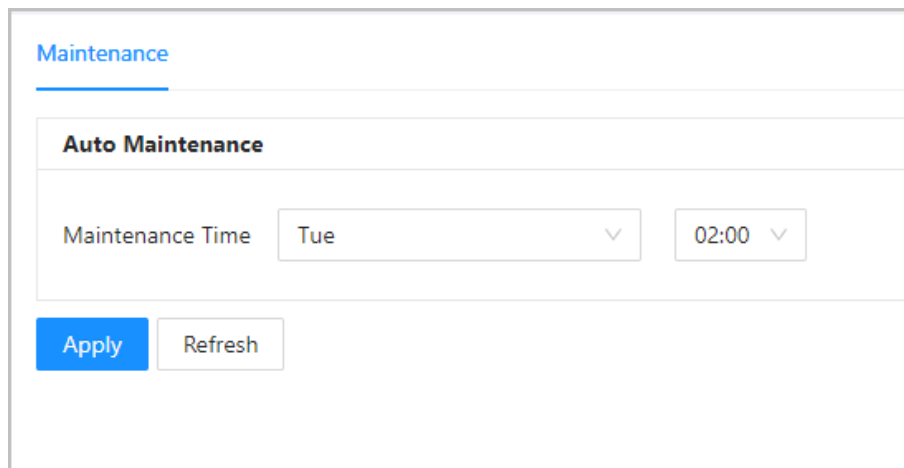

The screenshot shows a web interface titled "Maintenance". Underneath, there is a section titled "Auto Maintenance". In this section, there is a "Maintenance Time" label followed by two dropdown menus. The first dropdown menu is set to "Tue" and the second is set to "02:00". Below these dropdowns, there are two buttons: a blue "Apply" button and a white "Refresh" button.

- Step 3 Click **Apply.**

## 11.5 Update

### Procedure

- Step 1 Select **Maintenance Center > Update.**
- Step 2 Select ways to check the update.
  - **File Update** : Click **Browse** to add the updating file, and then click **Update.**
  - **Online Update**
    - ◇ **Auto Check for Updates** : Enable the function to check automatically whether there is a new system version.
    - ◇ **Manual Check** : Select the function to check whether there is a new system version.

Figure 11-5 Online Update

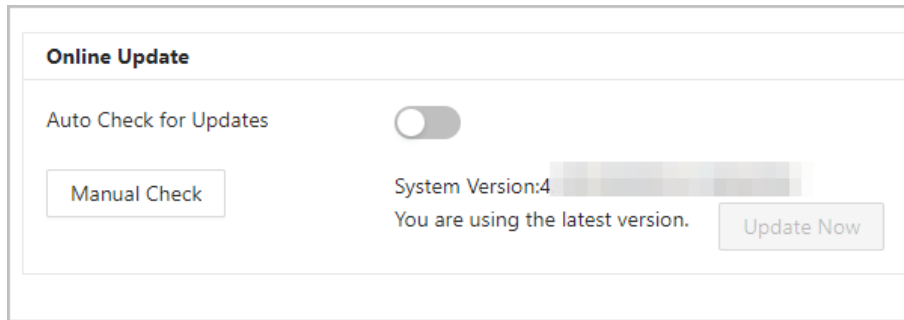

## 11.6 Advanced Maintenance

### Export

Select **Maintenance Center** > **Advanced Maintenance** > **Export** to export the serial number, firmware version, device operation logs and configuration information.

### Packet Capture

1. Select **Maintenance Center** > **Advanced Maintenance** > **Packet Capture**.
2. Enter the port of the device.
3. Click ▶ to start the packet sniffer backup.

Figure 11-6 Packet Capture

Packet Capture							
NIC	Device Address	IP 1: Port 1		IP 2: Port 2		Packet Sniffer Size	Packet Sniffer Back...
eth0	██████	Optional	Optional	Optional	Optional	0.00MB	▶
lo	██████	127.0.0.1	Optional	Optional	Optional	0.00MB	▶

# 12 Security Management

## 12.1 Security Status

On the home page, click , and then select **Security Status**.

Figure 12-1 Security status



## 12.2 System Service

### Procedure

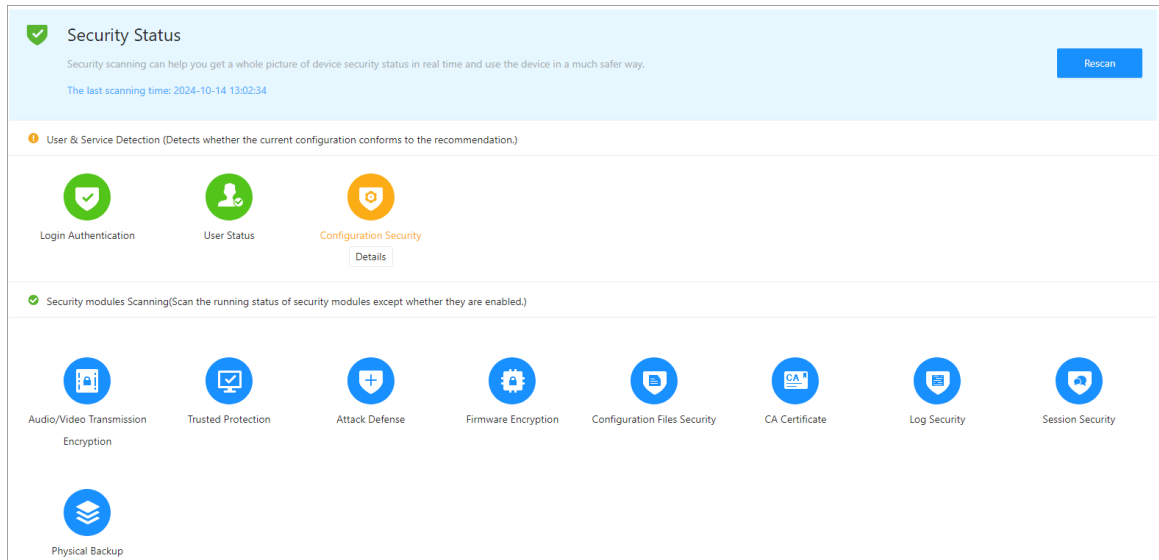
- Step 1** On the home page, click , and then select **System Service**.
- Step 2** Select a device certificate, and then enable the HTTPS function.

Figure 12-2 System service



- Step 3** Click **Apply**.

## 12.3 Attack Defense

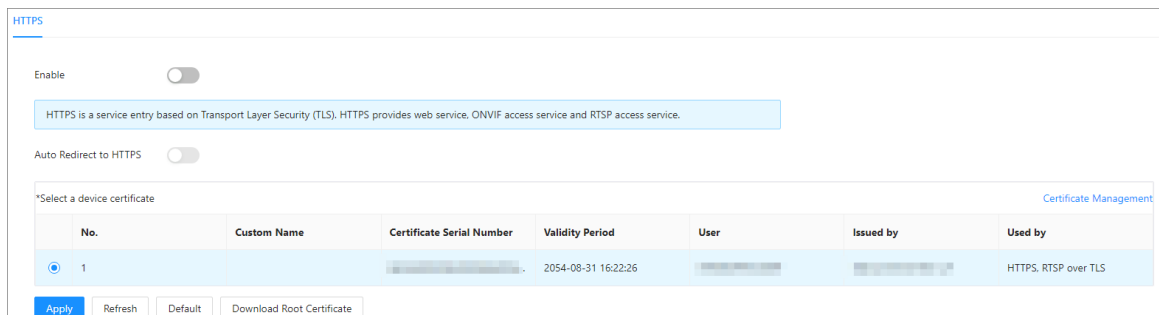
### 12.3.1 Firewall

You can enable different firewall types to control network access to the VTO.

#### Procedure

- Step 1** On the home page, click , and then select **Attack Defense > Firewall**.
- Step 2** Click  next to **Enable**.
- Step 3** Select the **Mode** as either **Allowlist** or **Blocklist**.
- Allowlist: Devices that have been granted an access.
  - Blocklist: Devices that have been forbidden an access.
- Step 4** Click **Add** to add the IP address for allowlist or blocklist.

Figure 12-3 Add



The screenshot shows a dialog box titled "Add" with a close button (X) in the top right corner. It contains four fields:

- Add Mode:** A dropdown menu with "IP" selected.
- IP Version:** A dropdown menu with "IPv4" selected.
- IP Address:** A text input field containing "10" followed by four empty boxes for the remaining octets.
- All Device Ports:** A toggle switch that is currently turned on (blue).

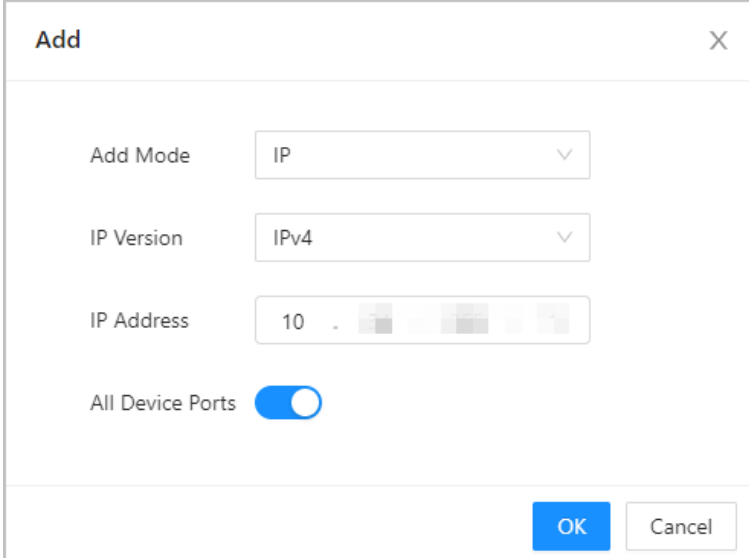
At the bottom right of the dialog box, there are two buttons: "OK" (highlighted in blue) and "Cancel".

- Step 5** Click **OK**.
- Step 6** Select an added IP address for allowlist or blocklist, and then click **Apply**.

Figure 12-4 Apply

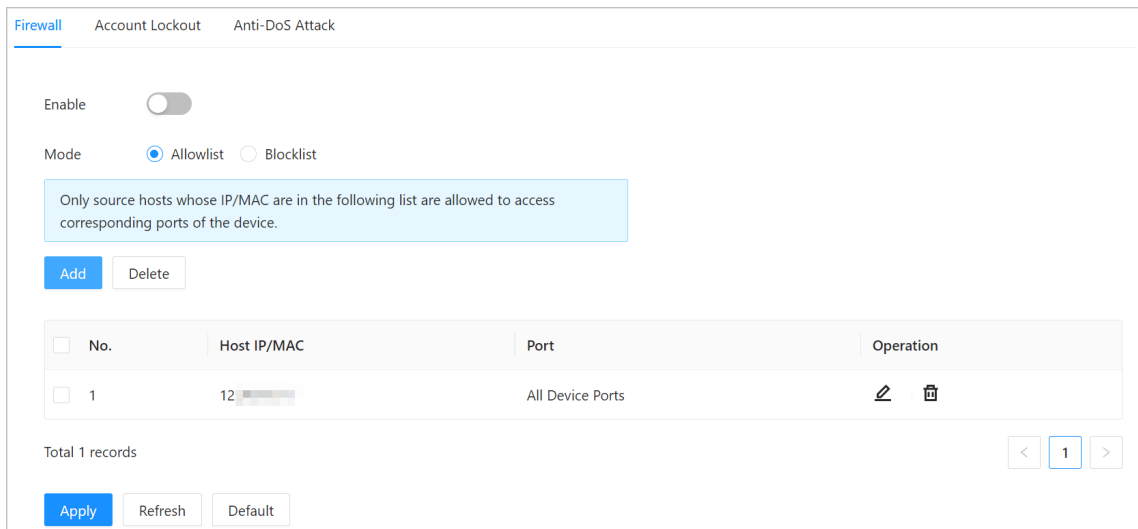

## 12.3.2 Account Lockout

### Procedure

- Step 1 On the home page, click , and then select **Attack Defense > Account Lockout**.
- Step 2 Configure the login attempts and lock time for device account and ONVIF user.

Figure 12-5 Account lockout



- Step 3 Click **Apply**.

## 12.3.3 Anti-DoS Attack

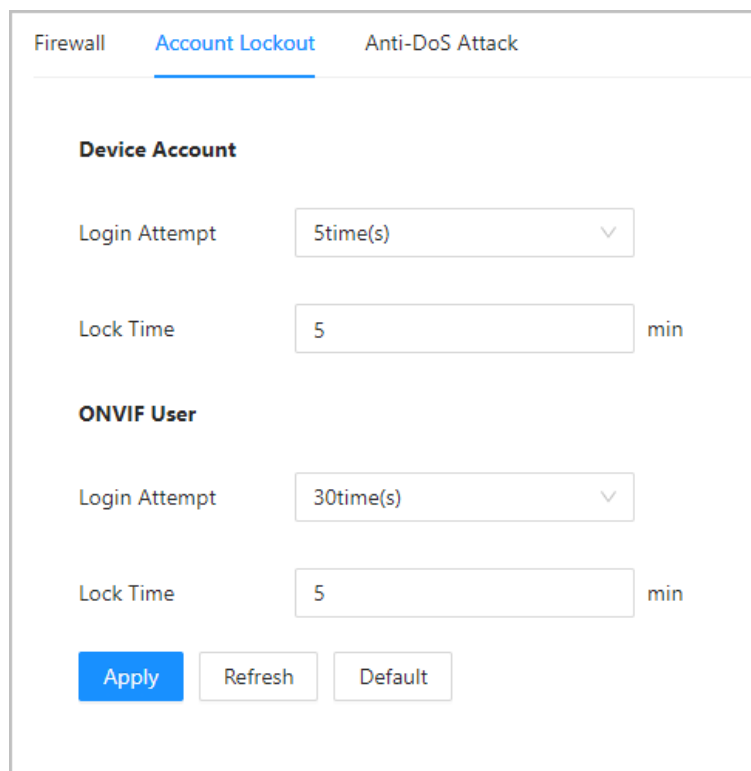
### Procedure

**Step 1** On the home page, click , and then select **Attack Defense > Anti-DoS Attack**.

**Step 2** Enable or disable the **SYN Flood Attack Defense** or **ICMP Flood Attack Defense** function.

Figure 12-6 Anti-DoS attack

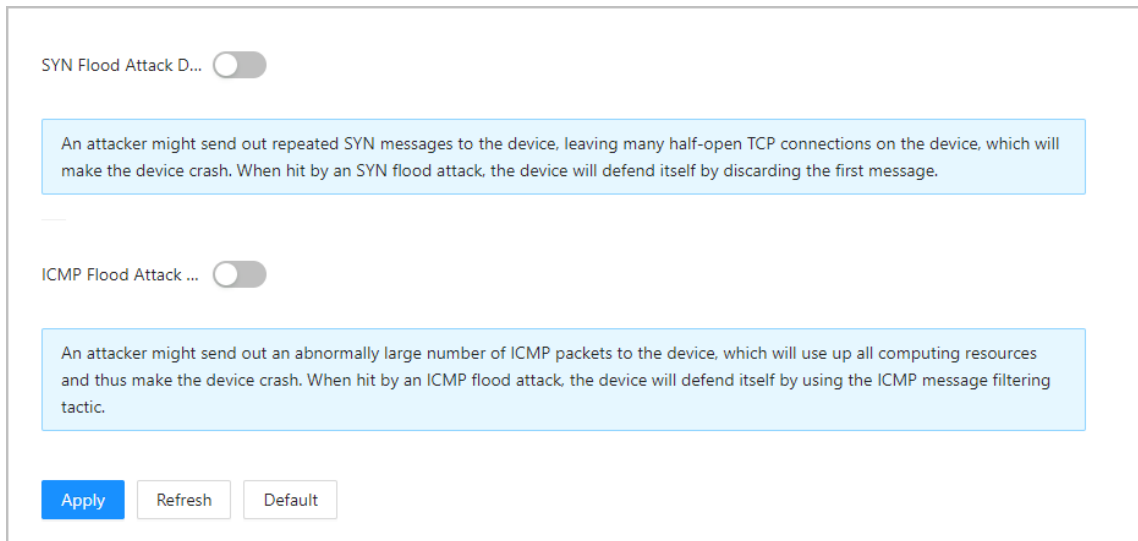

**Step 3** Click **Apply**.

## 12.4 CA Certificate

### Procedure

**Step 1** On the home page, click , and then select **CA Certificate**.

- Device Certificate

Figure 12-7 Device Certificate

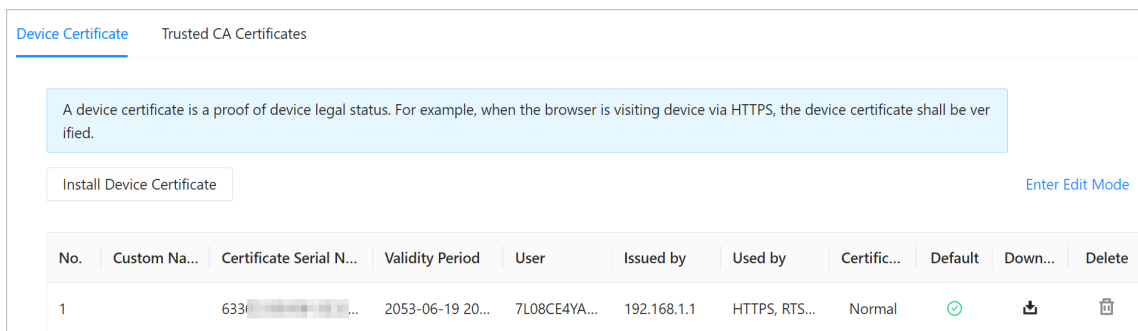

- Trusted CA Certificates



Figure 12-8 Trusted CA Certificates

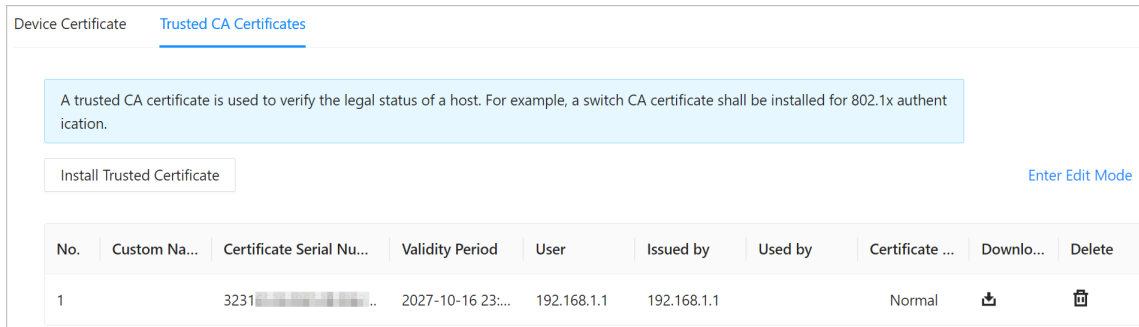

## 12.5 Video Encryption

### Procedure

- Step 1** On the home page, click , and then select **Video Encryption**.
- Step 2** Configure **Private Protocol** and **RTSP over TLS** parameters.

Figure 12-9 Video encryption

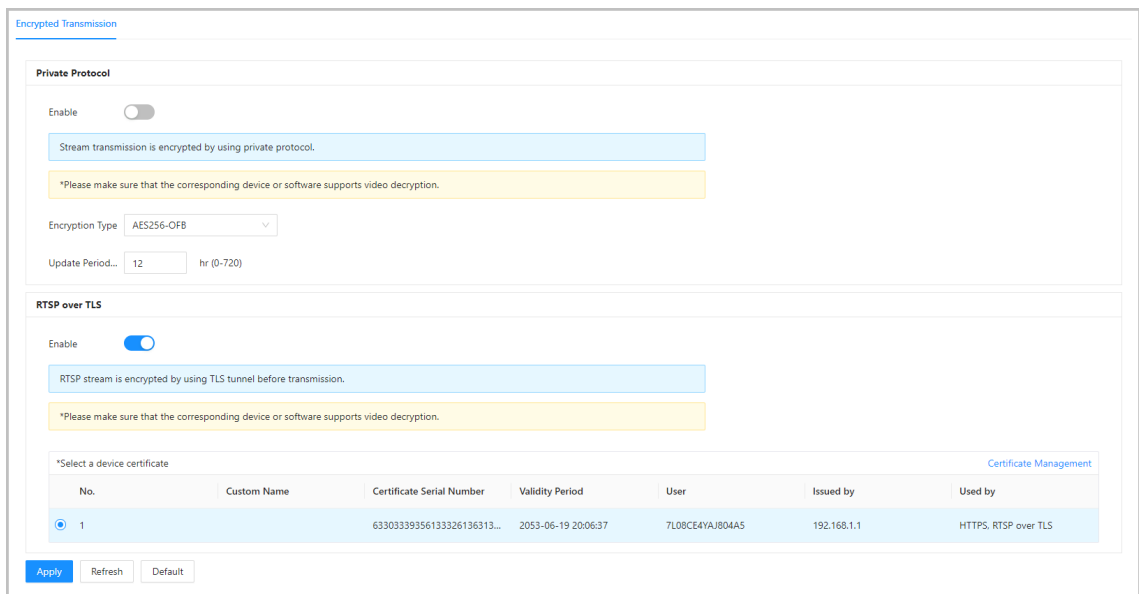

- Step 3** Click **Apply**.

## 12.6 Security Warning

### Procedure

- Step 1** On the home page, click , and then select **Security Warning**.
- Step 2** Enable event monitoring function, and then click **Apply**.

Figure 12-10 Security warning

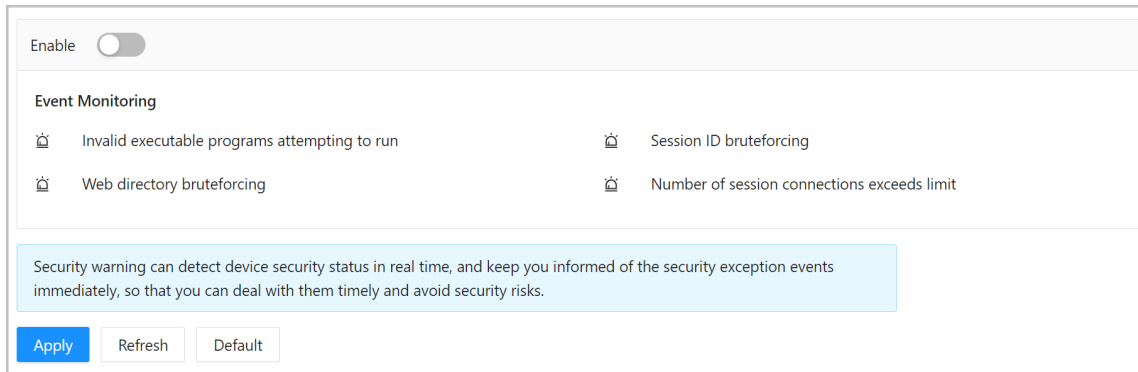

# 13 Button Model Configuration

The button model can be connected to the VTH to work as an alarm input button. Press the button on the front panel of the model, and then the VTH receives an alarm signal.

## 13.1 Cable Connection

Connect the KEY port of the button model to any one of the alarm input ports of the indoor monitor (VTH) with a cable thread.

Figure 13-1 Button model

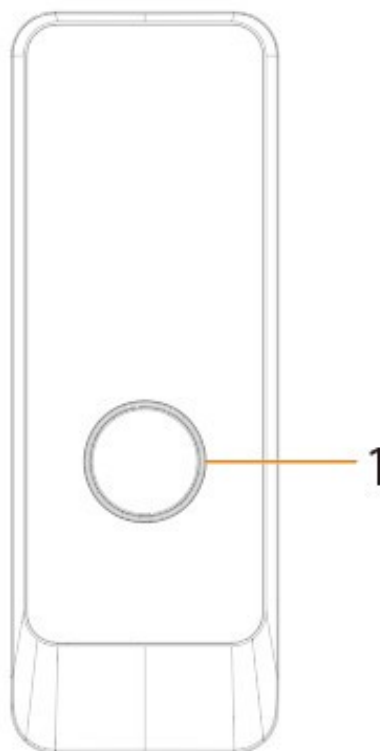
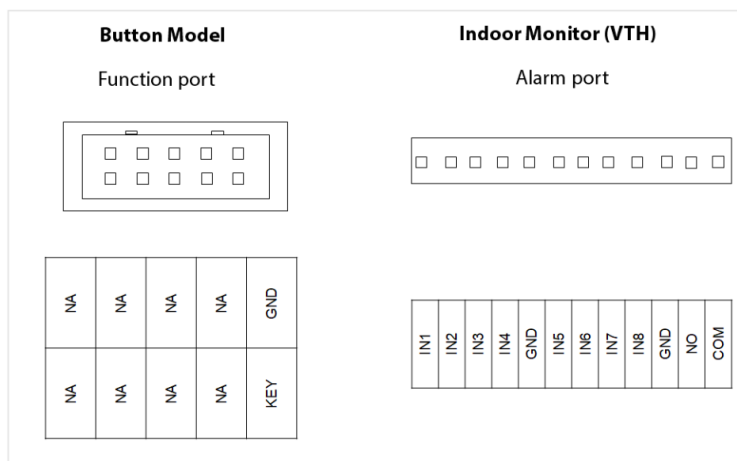

Table 13-1 Component

No.	Name	Function
1	Press button	The button model can be connected to the VTH. Press the button on the model and the VTH receives an alarm signal.

Figure 13-2 Cable connection



## 13.2 VTH Configuration

After completing cable connection, you need to set the **wired zone type** as **Doorbell** on the VTH to receive alarm signals once you press the button model.

### Procedure

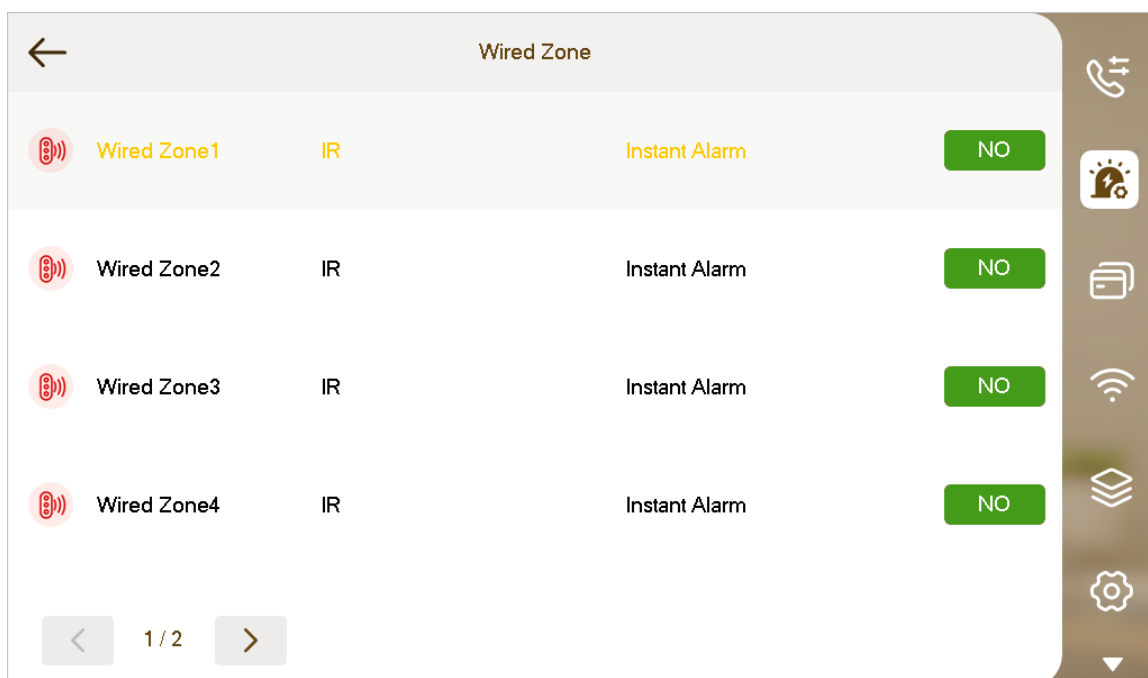

- Step 1 Power on the VTH.
- Step 2 Select **Setting** > **Alarm** > **Wired Zone** on the VTH.

Figure 13-3 Wired zone setting



- Step 3 Set the **Type** as **Doorbell**, and configure the rest of the parameters.

Table 13-2 Parameter description

Parameter	Description
Area	The number cannot be modified.
NO/NC	Select NO (normally open) or NC (normally closed) according to detector type. It must be the same as detector type.
Type	Select corresponding type according to detector type.
Status	<ul style="list-style-type: none"> <li>● <b>Instant Alarm</b> : After armed, if an alarm is triggered, the device produces siren at once and enters alarm status.</li> <li>● <b>Delay Alarm</b> : After armed, if an alarm is triggered, the device enters alarm status after a specified time, during which you can disarm and cancel the alarm.</li> <li>● <b>Bypass</b> : Alarm will not be triggered in the area. After disarmed, this area will restore to normal working status.</li> <li>● <b>Remove</b> : The area is invalid during arm/disarm.</li> <li>● <b>24 Hour</b> : Alarm will be triggered all the time in the area regardless of arm or disarm.</li> </ul>  <p>A zone in <b>Remove</b> status cannot be bypassed.</p>
Enter Delay	<p>After entering delay, when armed area triggers an alarm, entering armed area from non-armed area within the delay time period will not lead to linkage alarm. Linkage alarm will be produced if delay time comes to an end and it is not disarmed.</p> 
Exit Delay	<p>After arm, <b>Delay Alarm</b> area will enter arm status at the end of <b>Exit Delay</b>.</p>  <p>If multiple areas set the exit delay, screen prompt will conform to maximum delay time.</p> <p>Delay is only valid to the areas of <b>Delay Alarm</b>.</p>

# Appendix 1 Security Recommendation

## Account Management

### 1. Use complex passwords

Please refer to the following suggestions to set passwords:

- The length should not be less than 8 characters;
- Include at least two types of characters: upper and lower case letters, numbers and symbols;
- Do not contain the account name or the account name in reverse order;
- Do not use continuous characters, such as 123, abc, etc.;
- Do not use repeating characters, such as 111, aaa, etc.

### 2. Change passwords periodically

It is recommended to periodically change the device password to reduce the risk of being guessed or cracked.

### 3. Allocate accounts and permissions appropriately

Appropriately add users based on service and management requirements and assign minimum permission sets to users.

### 4. Enable account lockout function

The account lockout function is enabled by default. You are advised to keep it enabled to protect account security. After multiple failed password attempts, the corresponding account and source IP address will be locked.

### 5. Set and update password reset information in a timely manner

The device supports password reset function. To reduce the risk of this function being used by threat actors, if there is any change in the information, please modify it in time. When setting security questions, it is recommended not to use easily guessed answers.

## Service Configuration

### 1. Enable HTTPS

It is recommended that you enable HTTPS to access web services through secure channels.

### 2. Encrypted transmission of audio and video

If your audio and video data contents are very important or sensitive, it is recommended to use encrypted transmission function in order to reduce the risk of your audio and video data being eavesdropped during transmission.

### 3. Turn off non-essential services and use safe mode

If not needed, it is recommended to turn off some services such as SSH, SNMP, SMTP, UPnP, AP hotspot etc., to reduce the attack surfaces.

If necessary, it is highly recommended to choose safe modes, including but not limited to the following services:

- SNMP: Choose SNMP v3, and set up strong encryption and authentication passwords.
- SMTP: Choose TLS to access mailbox server.
- FTP: Choose SFTP, and set up complex passwords.
- AP hotspot: Choose WPA2-PSK encryption mode, and set up complex passwords.

### 4. Change HTTP and other default service ports

It is recommended that you change the default port of HTTP and other services to any port between 1024 and 65535 to reduce the risk of being guessed by threat actors.

## Network Configuration

### 1. **Enable Allow list**

It is recommended that you turn on the allow list function, and only allow IP in the allow list to access the device. Therefore, please be sure to add your computer IP address and supporting device IP address to the allow list.

### 2. **MAC address binding**

It is recommended that you bind the IP address of the gateway to the MAC address on the device to reduce the risk of ARP spoofing.

### 3. **Build a secure network environment**

In order to better ensure the security of devices and reduce potential cyber risks, the following are recommended:

- Disable the port mapping function of the router to avoid direct access to the intranet devices from external network;
- According to the actual network needs, partition the network: if there is no communication demand between the two subnets, it is recommended to use VLAN, gateway and other methods to partition the network to achieve network isolation;
- Establish 802.1x access authentication system to reduce the risk of illegal terminal access to the private network.

## Security Auditing

### 1. **Check online users**

It is recommended to check online users regularly to identify illegal users.

### 2. **Check device log**

By viewing logs, you can learn about the IP addresses that attempt to log in to the device and key operations of the logged users.

### 3. **Configure network log**

Due to the limited storage capacity of devices, the stored log is limited. If you need to save the log for a long time, it is recommended to enable the network log function to ensure that the critical logs are synchronized to the network log server for tracing.

## Software Security

### 1. **Update firmware in time**

According to the industry standard operating specifications, the firmware of devices needs to be updated to the latest version in time in order to ensure that the device has the latest functions and security. If the device is connected to the public network, it is recommended to enable the online upgrade automatic detection function, so as to obtain the firmware update information released by the manufacturer in a timely manner.

### 2. **Update client software in time**

It is recommended to download and use the latest client software.

## Physical Protection

It is recommended that you carry out physical protection for devices (especially storage devices), such as placing the device in a dedicated machine room and cabinet, and having access control

and key management in place to prevent unauthorized personnel from damaging hardware and other peripheral equipment (e.g. USB flash disk, serial port).